

Use & Care Guide
Manual de Uso y Cuidado
English / Español

Model/Modelo: 790.4262*

Kenmore Elite®

Slide-in Electric Range

Estufa a Inducción Deslizable

* = color number, número de color

P/N 139900700 Rev. A

Sears Brands Management Corporation
Hoffman Estates, IL 60179 U.S.A.
www.kenmore.com
www.sears.com



Table of Contents

Before Setting Surface Controls.....	8	Setting Oven Controls	17
Setting Surface Controls.....	13	Care and Cleaning	35
Before Setting Oven Controls	15	Before You Call	40
		Oven Baking	40
		Solutions to Common Problems	41

Kenmore Elite Warranty

When this appliance is installed, operated and maintained according to all supplied instructions, the following warranty coverage applies. To arrange for warranty service, call 1-800-4-MY-HOME® (1-800-469-4663).

U.S.A. Warranty Coverage

- One Year Limited Warranty on Appliance
For one year from the date of purchase, free repair will be provided if this appliance fails due to a defect in material or workmanship.
- Two Year Limited Warranty on Ceramic Cooktop (if equipped)
For two years from the date of purchase, if a ceramic cooktop fails due to thermal shock, or a ceramic cooktop element is defective, a free replacement part will be supplied. After the first year from purchase date, you are responsible for the labor cost of part installation.

All warranty coverage applies for only 90 days from the date of purchase if this appliance is ever used for other than private family purposes.

Canada Warranty Coverage

- Two Year Limited Warranty on Appliance
For two years from the date of purchase, free repair will be provided if any non-consumable part of this appliance fails due to defects in material or workmanship. If the appliance is ever used for other than private family purposes, this coverage applies for only 90 days from the purchase date. For information concerning possible additional coverage, call 1-800-4-MY-HOME®.

This warranty covers ONLY defects in material and workmanship, and will NOT pay for:

1. Cracks in a ceramic glass cooktop that are not a result of thermal shock.
2. Stains and scratches on a ceramic glass cooktop resulting from failure to maintain it properly according to all instructions supplied with the product.
3. Consumable items that can wear out from normal use, including but not limited to filters, belts, incandescent light bulbs, and bags.
4. A service technician to instruct the user in correct product installation, operation or maintenance.
5. A service technician to clean or maintain this product.
6. Damage to or failure of this product if it is not installed, operated or maintained according to all instructions supplied with the product.
7. Damage to or failure of this product resulting from accident, abuse, misuse or use for other than its intended purpose.
8. Damage to or failure of this product caused by the use of detergents, cleaners, chemicals or utensils other than those recommended in all instructions supplied with the product.
9. Damage to or failure of parts or systems resulting from unauthorized modifications made to this product.

Disclaimer of implied warranties; limitation of remedies

Customer's sole and exclusive remedy under this limited warranty shall be product repair as provided herein. Implied warranties, including warranties of merchantability or fitness for a particular purpose, are limited to one year or the shortest period allowed by law. Sears shall not be liable for incidental or consequential damages. Some states and provinces do not allow the exclusion or limitation of incidental or consequential damages, or limitation on the duration of implied warranties of merchantability or fitness, so these exclusions or limitations may not apply to you. This warranty applies only while this appliance is used in the United States and Canada.*

This warranty gives you specific legal rights, and you may also have other rights which vary from state to state and province to province.

* In-home repair service is not available in all Canadian geographical areas, nor will this warranty cover user or servicer travel and transportation expenses if this product is located in a remote area (as defined by Sears Canada Inc.) where an authorized servicer is not available.

Sears Brands Management Corporation, Hoffman Estates, IL 60179
Sears Canada Inc., Toronto, Ontario, Canada M5B 2C3

IMPORTANT SAFETY INSTRUCTIONS

Read all instructions before using this appliance.

This manual contains important safety symbols and instructions. Please pay attention to these symbols and follow all instructions given.

Do not attempt to install or operate your appliance until you have read the safety precautions in this manual. Safety items throughout this manual are labeled with a **WARNING** or **CAUTION** statement based on the risk type.

Definitions

⚠ This is the safety alert symbol. It is used to alert you to potential personal injury hazards. Obey all safety messages that follow this symbol to avoid possible injury or death.

⚠ WARNING - indicates a potentially hazardous situation which, if not avoided, may result in death or serious injury.

⚠ CAUTION - indicates a potentially hazardous situation which, if not avoided, may result in minor or moderate injury.

Important: indicates installation, operation, maintenance, or valuable information that is not hazard related.

⚠ WARNING Persons with a pacemaker or similar medical device should exercise caution using or standing near an induction unit while it is in operation, as the electromagnetic field may affect the working of the pacemaker or similar medical device. It would be advisable to consult your Doctor or the pacemaker or similar medical device manufacturer about your particular situation.

⚠ WARNING Do not leave children alone - children should not be left alone or unattended in the area where appliance is in use. They should never be allowed to sit or stand on any part of the appliance, including the storage drawer, lower broiler drawer, warmer drawer, or lower double oven.

⚠ WARNING



Tip Over Hazard

- A child or adult can tip the appliance and be killed.
- Verify the device is engaged with the countertops or that the device has been installed to the walls of the cabinet, the wall, or the floor as per the installation instructions
- Ensure the anti-tip device is re-engaged with the countertop, the walls of the cabinet, the wall, or the floor as per the installation instructions when the appliance is moved.
- Do not operate the appliance without the anti-tip device in place and engaged.
- Failure to follow these instructions can result in death or serious burns to children and adults.



To check if the anti-tip bracket is installed properly, use both arms to grasp the rear edge of the

appliance back. Carefully attempt to tilt appliance forward. When properly installed, the appliance should not tilt forward.

Refer to the anti-tip bracket installation instructions supplied with your range for proper installation.

⚠ WARNING Never cover any slots, holes, or passages in the oven bottom or cover an entire oven rack with materials such as aluminum foil. Aluminum foil linings may trap heat, causing a fire hazard.

Save these instructions for future reference.

IMPORTANT SAFETY INSTRUCTIONS

Read all instructions before using this appliance.

Important: This appliance has been tested and found to comply with the limits for a class B digital device, pursuant to Part 18 of the FCC rules. These limits are designed to provide reasonable protection against harmful interference in a residential installation. This unit generates, uses and can radiate radio frequency energy and, if not installed and used in accordance with the instructions, may cause harmful interference to radio communications. However there is no guarantee that interference will not occur in a particular installation. If this unit does cause harmful interference to radio or television reception, which can be determined by turning the unit off and on, the user is encouraged to try to correct the interference by one or more of the following measures:

- Reorient or relocate the receiving antennae.
- Increase the distance between the unit and receiver.
- Connect the unit into an outlet or a circuit different from that to which the receiver is connected.

⚠ WARNING Stepping, leaning or sitting on the door or drawers of a range can result in serious injuries and also cause damage to the appliance. Do not allow children to climb or play around the range. The weights of a child on an open oven door, may cause the range to tip, resulting in serious burns or other injury.

⚠ WARNING Storage in or on appliance—flammable materials should not be stored in an oven, near surface units, or in the storage drawer, warmer drawer or lower oven. This includes paper, plastic and cloth items, such as cookbooks, plastic ware and towels, as well as flammable liquids. Do not store explosives, such as aerosol cans, on or near the range.

⚠ CAUTION Do not store items of interest to children in the cabinets above a range on the backguard of the ranges. Children climbing on the range to reach items could be seriously injured.

⚠ CAUTION Do not touch surface heating units or surface cooking elements, areas near these units or elements, or interior surface of the oven. Surface heating areas and oven heating elements may be hot even though they appear cool. Areas near surface cooking units may become hot enough to cause burns. During and after use, do not touch, or let clothing or other flammable materials touch these areas until they are cool. These areas may include the cooktop, surfaces facing the cooktop, oven vent areas, oven door, and oven window.

⚠ CAUTION Wear proper apparel. Loose-fitting or hanging garments should never be worn while using this appliance. Do not let clothing or other flammable materials come into contact with hot surfaces.

⚠ CAUTION Do not heat unopened food containers. Build-up of pressure may cause container to burst and result in injury.

⚠ CAUTION When heating fat or grease, watch it closely, Fat or grease may catch fire if it becomes too hot.

⚠ CAUTION Do not use water or flour on grease fires. Cover the fire with a pan lid, use baking soda, or use a dry chemical or foam type extinguisher.

⚠ CAUTION Use dry potholders. Moist or damp potholders on hot surfaces may result in burns from steam. Do not let potholders touch hot cooking areas. Do not use towels or other bulky cloths.

Important: Read and follow these instructions and precautions for unpacking, installing, and servicing your appliance:

- Remove all tape and packaging before using the range. Destroy the carton and plastic bags after unpacking the range. Never allow children to play with packaging material.

IMPORTANT SAFETY INSTRUCTIONS

Read all instructions before using this appliance.

- Proper installation—Be sure your appliance is properly installed and grounded by a qualified technician in accordance with the National Electrical Code ANSI/NFPA No. 70 latest edition, and local electrical code requirements. In Canada, install in accordance with CSA Standard C22.1, Canadian Electrical code, Part 1, and local electrical code requirements. Install only per installation instructions provided in the literature package for this range.
- User servicing—Do not repair or replace any part of the appliance unless specifically recommended in the manuals. All other servicing should be done only by a qualified technician. This reduces the risk of personal injury and damage to the range.
- Ask your dealer to recommend a qualified technician and an authorized repair service. Know how to disconnect the power to the range at the circuit breaker or fuse box in case of an emergency.
- Never modify or alter the construction of a range by removing the leveling legs, panels, wire covers, anti-tip brackets/screws, or any other part of the range.
- Do not attempt to operate the range during a power failure. If the power fails, always turn off the range. If the range is not turned off and the power resumes, the range will begin to operate again.
- Be sure to have an appropriate foam-type fire extinguisher available, visible, and easily accessible located near the appliance.
- Cold temperatures can damage the electronic control. When using this appliance for the first time, or when the appliance has not been used for an extended period of time, be sure the appliance has been in temperatures above 32°F (0°C) for at least 3 hours before turning on the power to the appliance.
- Remove the oven door from any unused range if it is to be stored or discarded.

Important: Important Safety Notice - The California Safe Drinking Water and Toxic Enforcement Act requires the Governor of California to publish a list of substances known to cause cancer, birth defects or other reproductive harms, and requires businesses to warn customers of potential exposures to such substances.

Important Instructions For Ceramic Glass Cooktops

- Do not cook on a broken cooktop. If the cooktop is broken, cleaning solutions and spills may penetrate the cooktop and create a risk of electric shock. Contact a qualified technician immediately.
- Clean cooktop with caution. If a wet sponge or cloth is used to wipe spills on a hot cooking area, be careful to avoid steam burns. Some cleaners can produce noxious fumes if applied to a hot surface.

Save these instructions for future reference.

IMPORTANT SAFETY INSTRUCTIONS

Read all instructions before using this appliance.

Important Instructions for Using your Cooktop

- Know which keys controls each surface cooking zone. Place pan with food on the cooking zone before turning it on. Turn the cooking zone off before removing the pan.
- Use proper pan size. This appliance is equipped with induction cooking zones of different sizes. Select utensils specifically manufactured or approved for induction cooking. Pans should have flat bottoms that match the induction cooking zone size. Using the proper utensil on the cooking zone will improve efficiency.
- To reduce the risk of burns, ignition of flammable materials, and spills due to unintentional contact with the utensil, the utensil handles should be turned inward and not extend over other cooking zones.
- Never leave surface cooking zones unattended. Boil-overs may cause smoking and greasy spills may ignite. A pan that has boiled dry could be damaged and may damage the cooktop.
- When you are flaming foods under a ventilating hood, turn on the fan.

Important Instructions for Using Your Oven

- Never use your appliance for warming or heating the room.
- Use care when opening oven door, lower oven door, or warmer drawer (some models). Stand to the side of the range when opening the door of a hot oven. Let hot air or steam escape before you remove or replace food in the oven.
- Keep oven vent ducts clear. The oven vent is located below the control panel for models with a ceramic glass cooktop. Touching surfaces in this area when the oven is on may cause severe burns. Do not place plastic or heat-sensitive items on or near the oven vent. These items can melt or ignite.
- Always handle oven racks when the oven is cool. Place oven racks in desired positions while the oven is cool. If a rack must be moved while the oven is hot, use extreme caution. Use potholders and grasp the rack with both hands to reposition. Do not let potholders contact the hot heating elements in the oven. Remove all cookware and utensils before moving the rack.
- Do not use a broiler pan without its insert. Broiler pans and inserts allow dripping fat to drain away from the high heat of the broiler. Do not cover the broiler insert with aluminum foil; exposed fat and grease could ignite.
- Do not use aluminum foil or other protective liners to line the oven bottom. Only use aluminum foil as recommended in this manual. Improper installation of these liners may result in risk of electric shock or fire.
- Do not cook food on the oven bottom. Always cook in proper cookware and always use the oven racks.

Save these instructions for future reference.

IMPORTANT SAFETY INSTRUCTIONS

Read all instructions before using this appliance.

Important Instructions for Cleaning Your Range

⚠ CAUTION Before manually cleaning any part of the range, be sure all controls are turned OFF and the range is cool. Cleaning a hot range can cause burns

- Clean the range regularly to keep all parts free of grease that could catch fire. Pay particular attention to the area around each surface element. Do not allow grease to accumulate.
- Always follow the manufacturer's recommended directions for use of kitchen cleaners and aerosols. Be aware that excess residue from cleaners and aerosols may ignite causing damage and injury.
- Clean ventilating hoods frequently. Grease should not be allowed to accumulate on the hood or filter. Follow the manufacturer's instructions for cleaning hoods.

Self-Cleaning Ovens

- Use the self-clean cycle to clean only the parts listed in this manual. Before using self-clean, remove the broiler pan, any food, utensils, and cookware from the oven. Remove oven racks unless otherwise instructed.
- Do not use oven cleaners. No commercial oven cleaner, oven liner, or protective coating of any kind should be used in or around any part of the oven.
- Do not clean the oven door gasket. The door gasket is essential for a good seal. Do not rub, damage, or move the gasket.
- Some birds are extremely sensitive to the fumes given off during the self-clean cycle of any range. Move birds to another well-ventilated room.

Grounding Instructions

⚠ WARNING Avoid fire hazard or electrical shock. Failure to follow this warning may cause serious injury, fire, or death.

For personal safety, this appliance must be properly grounded. For maximum safety, the power cord must be plugged into an electrical outlet that is the correct voltage, is correctly polarized and properly grounded according to local codes. It is the personal responsibility of the consumer to have the appropriate outlet with the correct, properly grounded wall receptacle installed by a qualified electrician. It is the responsibility and obligation of the consumer to contact a qualified installer to assure that the electrical installation is adequate and is in conformance with all local codes and ordinances.

See the installation instructions packaged with this appliance for complete installation and grounding instructions.

Product Record

The model and serial number identification label is located on the upper left of the oven frame. Open the door to see the serial label.

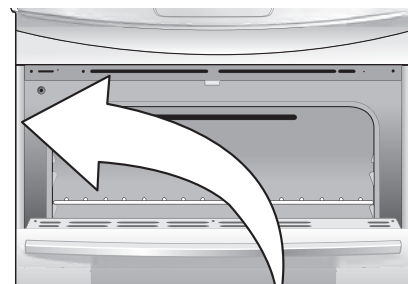

Record the date of purchase, model and serial number of your product.

Model Number: _____

Serial Number: _____

Date of Purchase: _____

Save your sales receipt for future reference.

Before Setting Surface Controls

Using Correct Cookware Type

The magnetic Cooking Zone sensors located below the cooktop surface require the use of cookware made with magnetic material in order to start the heating process on any of the cooking zones.

When purchasing pans, look for cookware specifically identified by the manufacturer for use with Induction cooktops. If you are not sure, use a magnet to test whether the cookware type will work. If a magnet sticks to the bottom of the cookware, the material type is correct for induction cooking (Figure 1)..

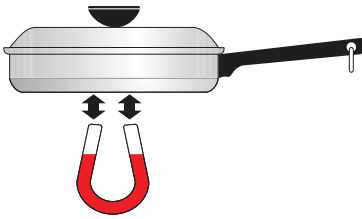

Figure 1: Check pan for magnetic properties

It is recommended to always use heavier high quality stainless steel cookware on your induction cooktop surface. This will greatly reduce the possibility of developing scratches on the ceramic surface.

Even quality cookware can scratch the cooktop surface, especially if cookware is slid over the ceramic cooktop surface without being lifted up. Over time sliding any type of cookware over the ceramic cooktop will likely alter the overall appearance of the cooktop. Eventually the buildup of scratches will make cleaning the surface difficult and degrade the overall appearance of the cooktop.

Induction Cooktop Features

- When the induction cooktop is turned on, the cooktop surface remains much cooler than standard ceramic cooktops.

CAUTION The cooking zone may appear to be cool while turned on and after they have been turned off. But the glass surface may be hot from residual heat transferred from the cookware and burns may occur.

- **Magnetic detector.** The coil sensor automatically detects if a pan is magnetic. If it is not, the cooking zone will not activate.
- **Pan size detection.** The pan detection sensor automatically adapts the size of cooking zone to the pan sizes in use.
- **Efficiency.** Induction cooking heats faster while using less energy. Induction power boils more quickly and simmers more evenly.

Use Quality Cookware in Good Condition

The cookware used with the Induction Cooktop should have flat bottoms that make good contact with the entire surface of the Cooking Zone. Check for flatness by rotating a ruler across the bottom of the cookware (Figure 2). Be sure to follow all the recommendations for using cookware.

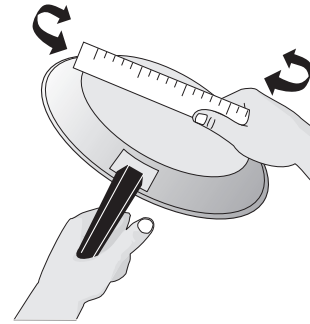

Figure 2: Check flatness of cookware

Important note:

- Use cookware made with the correct material type for induction cooking.
- Use quality cookware with heavier bottoms for better heat distribution allowing for more even cooking results.
- The pan size should match the amount of food being prepared.

Do not let pans boil dry.

This may cause permanent damage in the form of breakage, fusion, or marring that can affect the ceramic cooktop. Do not use dirty pans with grease buildup. Always use pans that are easy to clean after cooking.

CAUTION Do not touch hot cookware or pans directly with hands. Always use oven mitts or pot holders to protect hands from burns.

CAUTION Do not slide cookware across the cooktop surface. Doing so may permanently damage the appearance of the ceramic cooktop.

Induction Cookware

The induction cooking zones have pan sensing to let you know that the cookware is in proper position for cooking. The display showing the selected power setting will flash on and off if the pan is not placed properly on the cooking zone. Move the pan to the center of the zone and the display will stop flashing.

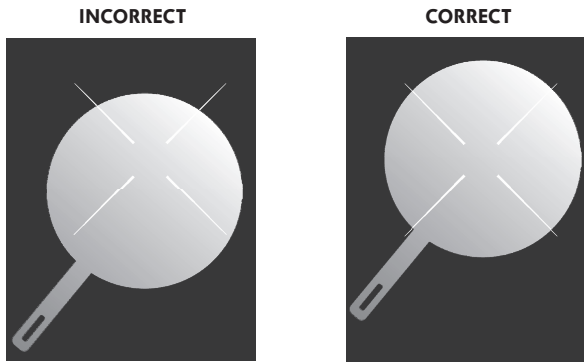
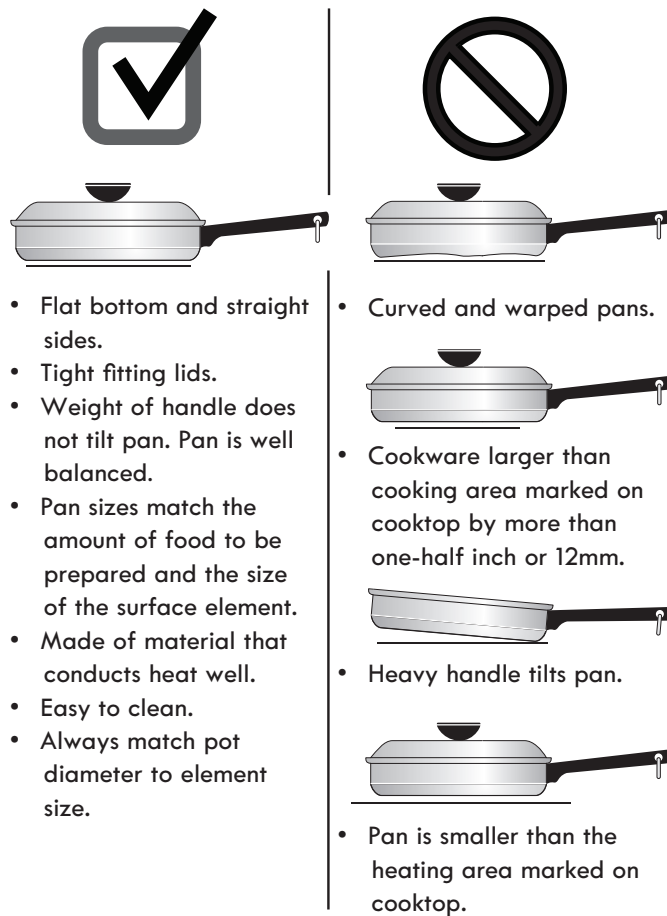

Figure 3: How to set cookware for proper induction cooking



Important note: If the cookware meets any of these incorrect conditions, one or more of the cooking zones will not heat indicated by a flashing power level display. Correct the problems before attempting to reactivate the cooktop.

Minimum Pan Size Requirements

Important: Pan bottoms should not extend more than 1/2" (13mm) beyond outer Cooking Zone (Induction).

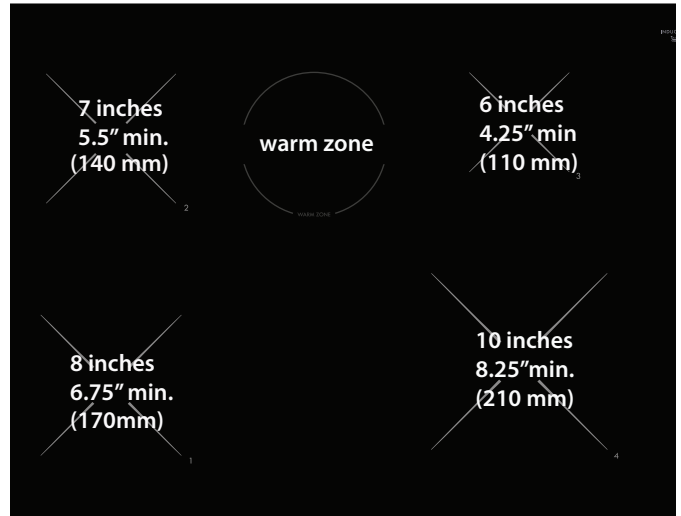

Figure 4: Induction cooking zone sizes

Pan Sensing-Induction Cooking Zones

Minimum Pan Size

Induction cooking zones require a minimum pan size in order to activate. The cookware bottom must meet the minimum area for the heating process to begin.

If a pan that is induction-capable is centered properly but is too small, the cooking zone display will flash the last power level setting and the pan will not heat. Select a larger pan that meets the minimum size requirement to activate the cooking zone.

Maximum Recommended Pan Size

The graphics on each cooking zone location are your guides to the correct maximum pan size for that zone (See Figure 4).

It is recommended to not use pans with bottoms that extend more than 1/2" (13 mm) beyond any of the longer line marks provided on the cooktop.

The cookware must make full contact with the ceramic glass surface. Cookware should not rest on or touch the metal edges of the cooktop.

Before Setting Surface Controls

Cooktop Display Windows

The cooktop controls provide a digital display for each of the radiant surface elements located on the cooktop. Power levels and messages are easily monitored and adjusted using the corresponding control key in combination with the window displays.

The Available Power Level Settings

The cooktop control will display heat levels ranging from Power Boost (Pb) to Hi to Lo and OFF (Figure 5). The settings between 9.5 and 3.0 (Figure 6) decrease or increase in increments of .5 (1/2). The settings between 2.8 and 1.2 (Figure 6) are Simmer settings which decrease or increase in increments of .2 (1/5) to Lo for more precise settings at lower heat levels.

The highest setting Power Boost (Pb) provides the highest possible power for 10 minutes, and if not changed to a lower power setting, will automatically lower the power to the HI setting.



Figure 5: Range from Power Boost (Pb) to Hi setting to Lo and OFF (blank display)



Figure 6: Settings between 9.5 and 3.0 (.5 increments) and settings between 2.8 and 1.2 (.2 increments)

Hot Element Indicator Message (HE)

⚠ CAUTION After using any of the cooking zones on the cooktop, the glass surface may be hot from residual heat transferred from the cookware and burns may occur if surface is touched.

The control monitors the temperature of the cooktop and displays the message HE (hot element) warning when the cooktop is still too hot to touch (Figure 7). The HE will remain on until the cooktop has cooled to a moderate level. If the HE message appears in the display, the control can still be turned on again for use.



Figure 7: Hot element indicator

Sabbath Feature (Sb) Message

The cooktop display windows will show the -- message whenever the Sabbath feature is active (Figure 8). The oven control display will show Sab.

When activated, the Sabbath feature locks the cooktop and only allows oven operation. See "Setting the Sabbath feature (for use on the Jewish Sabbath and Holidays)" on page 30 for complete instructions.



Figure 8: Display indicating cooktop is locked when oven is set for Sabbath

Pan Sensing

The cooking zone sensors located below the cooktop surface require that certain cookware conditions are met before the induction cooking zones can operate. If a cooking zone is activated and no cookware is detected, then zone display will flash with the last power level setting (Figure 9). If improper cookware is used, the cooking zones may not heat.

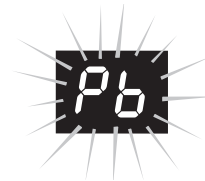

Figure 9: Display will flash if pan is not correctly centered or if no pan is on the cooking zone

The conditions that generate a flashing message are illustrated in "Induction Cookware" on page 9. If the problem or problems are not corrected, the cooking zone will automatically turn off after three minutes.

Power Boost Feature

Your induction cooktop is equipped with a power boost (Pb) feature on each cooking zone. The power boost is used to bring large quantities of water or food to cooking temperature at the fastest speed possible. The power boost feature will generate the highest power for a maximum of 10 minutes, then will continue to heat at Hi position.

To turn on the power boost feature:

Press ON/OFF for the cooking zone of your choice and press Hi.

To lower the power setting press Lo.

To turn off the power boost press ON/OFF.

Power Sharing

In order to give you more flexibility, your induction cooktop is equipped with more cooking zones than the number of induction generators. Each of those generators is assigned to power a specific cooking zone (Figure 10). Two cooking zones are assigned to each generator. To be able to give you access to the highest power ratings, the generator will focus its power onto only one cooking zone. If you use more than one cooking zone at high power on the same generator, the generator will need to **share** its power to both cooking zones, thus lowering the power level of one of the cooking zones.

When you are **sharing** power (cooking in both zones), the last zone set will cook at the power setting you selected. The other zone will experience a slight decrease from its power setting if both zones are set high enough.

To get the highest power output from your cooking zones, cook with only one cookware per generator. If you need to use most of your cooking zones at once, start your cooking process on only one cooking zone within the generator heating section and then add your second cookware on the second cooking zone when the first one has already reached its cooking temperature.

Remember to select the power setting last for the cooking zone you want to maintain.

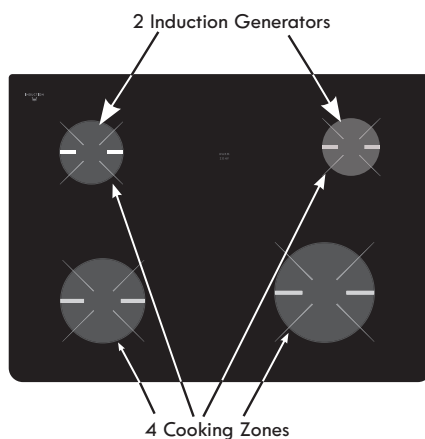

Figure 10: Cooking zone and induction generator locations

Operational Noises

The electronics generating the induction fields can produce some sounds as the cookware is heating. But they do produce heat at high power level.

A soft-sounding cooling fan activates when the unit is running multiple cooking zones at once or when a cooking zone is set at very high power settings.

Any buzzing sound you could hear from your cooktop is not coming from the electronics but from the cookware you are using. Here are some causes of this noise:

- Most induction-ready cookware are made of several layers of materials. An encapsulated steel layer is usually used to harness the induction field and transform it into heat, which is then transferred to the other materials by radiant energy. The induction field will cause the steel layer to vibrate against the other materials in which it is encapsulated. This is the most common cause of noise from the induction process. This buzzing only happens at the higher power level settings. Note that high quality cookware manufacturers weld this steel layer in place which lowers or cancel this noise.
- Light weight cookware may also vibrate. We recommend using heavy weight quality cookware.
- Cookware with warped bottoms can vibrate on the ceramic glass surface at high power settings.

⚠ CAUTION The power output of your induction cooktop is capable of warping an empty pan. Never use the higher power settings on an empty pan. Even the highest quality cookware is vulnerable to warping.

- Riveted handles on cookware can also cause buzzing sounds from the vibrations.
- Solid cast iron and enamelware cookware should not emit any noise. Top quality cookware made of several layers should also be relatively quiet.

Before Setting Surface Controls

Cooktop Lockout (--)

Use the Cooktop Lockout to lock all surface elements from being accidentally turned on. This feature will only lockout the cooktop features.

To turn the Cooktop Lockout feature ON:

1. Be sure all surface element controls are off.
2. Press and hold **COOKTOP LOCKOUT** key until acceptance tone sounds (about 3 seconds).

When the cooktop is locked, the cooktop locked indicator icon will appear in the oven control display window (Figure 11).



Figure 11: Cooktop lockout indicator

The (--) message will appear in the cooktop display windows whenever the cooktop lockout feature is active (Figure 12).



Figure 12: Dashes indicating that cooktop feature is locked

If a triple beep sounds (entry error tone) instead, check and be sure all surface elements are turned off before activating the cooktop lockout feature.

To turn the Cooktop Lockout feature off:

Press and hold **COOKTOP LOCKOUT** key until acceptance tone sounds (about 3 seconds). The cooktop locked indicator light will turn off and the cooktop may be used for normal cooking operations.

Important notes:

If cooktop lockout is active and a power failure occurs, when power is restored the cooktop will remember the setting and remain locked. Starting a Self Clean cycle will automatically turn on the cooktop lockout feature. The cooktop will remain locked until the self clean cycle is finished and the oven door has unlocked.

Be sure to read the detailed instructions for ceramic glass cooktop maintenance and cleaning in the Care & Cleaning and Before You Call sections of this Use & Care Guide.

Home Canning

Be sure to read and observe all the following points when home canning with your appliance. Check with the United States Department of Agriculture (USDA) website and be sure to read all the information they have available as well as follow their recommendations for home canning procedures.

Tips and procedures for canning foods:

- Use only quality flat bottom canners when home canning.
- Use a straight-edge to check canner bottom.
- Use only a completely flat bottom canner with no ridges that radiate from the bottom center when home canning using a ceramic cooktop.
- Make sure the diameter of the canner does not exceed 1/2 inch beyond the surface element markings or burner. It is recommended to use smaller diameter canners on electric coil and ceramic glass cooktops.
- Start with hot tap water to bring water to boil more quickly.
- Use the highest heat setting when first bringing the water to a boil. Once boiling is achieved, reduce heat to lowest possible setting to maintain that boil.
- Never place or straddle a cooking utensil over two different surface cooking areas at the same time. This will cause uneven heating results and may cause the ceramic cooktop to fracture.

Setting Surface Controls

Operating Induction Cooking Zones

Start most surface cooking on a higher setting and then adjust to a lower setting to finish cooking.

The suggested settings may vary slightly depending on the cookware design, quality, and amount of food being prepared (See [Table 1](#)).

Be sure to use quality cookware that is constructed with magnetic base material and meets the minimum and maximum pan size requirements.

To operate induction cooking zones:

CAUTION Unlike radiant surface elements, induction cooking zones do not glow red. The glass surface may be hot from residual heat transferred from the cookware and burns may occur. Do not touch hot cookware or pans directly with hands. Always use oven mitts or pot holders to handle cookware.

1. Place induction cookware on the desired cooking zone.
2. To activate the cooking zone, press **ON/OFF**.
3. Adjust the power level pressing **HI** or **LO**. This will increase or decrease the power level. Power levels 9.5 through 3.0 decrease and increase by 0.5 increments (1/2). Power levels from 2.8 to Lo (the lowest power level available) will increase or decrease in increments of 0.2 (2/10th's).
4. Once cooking is complete, turn the control off and remove cookware.

Table 1: Suggested cooking zone power level settings*

Settings	Type of cooking
Power boost (Pb)	Use to start heating pans that contain large amounts of food or to bring large pans of water to boil
High (8.0-Hi)	Start most foods, bring water to a boil, pan broiling
Medium high (5.0-8.0)	Continue a rapid boil, fry, deep fat fry
Medium (4.0-5.0)	Maintain a slow boil, thicken sauces and gravies or steam vegetables
Medium Low (2.0-4.0)	Keep foods cooking, poach, stew
Low (Lo - 2.0)	Keep warm, melt, simmer

*The suggested power level settings shown in [Table 1](#) are based on cooking with medium sized pans with lids. Be sure to make any further setting adjustments needed for best surface cooking results. The size and type of utensil used, as well as the amount and type of food being cooked, will influence the setting needed for best cooking results.

CAUTION Do not place flammable items (plastic salt and pepper shakers, spoon holders, plastic wrappings, etc.) on the cooktop when in use. These items could melt or ignite if placed too close to hot cookware.

CAUTION The cooking zones may appear to have cooled after they have been turned off. The glass surface may still be hot from residual heat and burns may occur if the cooktop is touched before it has cooled sufficiently.

Pan Preheat Recommendations

Induction cooking may decrease the amount of time required to preheat a cooking utensil compared to cooking on a radiant element cooktop or gas surface burner.

Whenever using the cooktop or oven, always pay close attention to all food items cooking and remain attentive until all the cooking is complete.

Important note:

Remember that induction surface cooking will initially heat the cooking utensil very quickly.

Important:

- The **HE** (hot element) message will appear in the display windows once a heating element or cooking zone is turned off and will remain on until the heating surface area or areas have cooled sufficiently.
- Do not allow aluminum foil, or any material that can melt, to make contact with the ceramic glass cooktop. If these items melt, they may damage the ceramic cooktop.
- The pan sensor will detect if the cookware is moved from the center of any active induction cooking zone, and the cookware will no longer heat. The affected cooking zone display window will flash until the cookware is moved back to the center of the cooking zone. If the cookware is properly centered on the cooking zone, the zone will resume heating. The cooking zone will remember the power level setting for up to three minutes before the cooking zone will automatically shut off.

Setting Surface Controls

Cooktop Operational Noises

The electronic processes involved in induction cooking may create some background noises. You may hear a slight buzzing sound when cooking on the cooktop. These noises are part of the induction cooking process and are considered normal.

Some cookware will buzz depending on the construction or base material. The buzz may be more noticeable if the contents of the pan are cold. As the pan heats, the noise will decrease. The noise will also decrease if the power level setting is reduced.

Important note:

When using the induction cooktop, operational noises are more noticeable while cooking at the Pb level. Very loud noises are not part of normal induction cooking.

Warm Zone

The purpose of the warm zone is to keep foods at serving temperatures and to warm oven-safe dishware. Cover all food on the warm zone with a lid to maintain quality. Always start with hot food. Do not heat cold food with the warm zone. For best results when warming pastries or breads, the cover should have an opening to allow moisture to escape. Do not use plastic wrap to cover food. Plastic may melt onto the surface and be difficult to remove. Use only dishware, utensils, and cookware recommended for oven and cooktop use.

To set the warm zone control:

⚠ WARNING Food Poisoning Hazard. Do not heat cold food on the warm zone. Doing so can result in food poisoning or sickness.

⚠ CAUTION The warm zone is radiant heat, but it will not glow red when it is hot. To avoid possible burns, always use potholders or oven mitts when moving food to and from the warm zone because cookware and plates will be hot.

⚠ CAUTION Radiant surface elements may appear to have cooled after they have been turned off. The glass surface may still be hot and burns may occur if the glass surface is touched before it has cooled.

⚠ CAUTION Do not place flammable items (plastic salt and pepper shakers, spoon holders, plastic wrappings, etc.) on top of the range when it is in use. These items could melt or ignite. Pot holders, towels, or wooden spoons could catch fire if placed too close to the surface elements.

1. Place cookware on the warm zone.
2. Press **ON/OFF**. The display will show **--** and the warm zone indicator light will turn on. Press **LO** to set warm zone to lowest setting (**1**). Press **HI** to toggle to medium (**2**) or high (**3**). The warm zone levels can be changed by pressing **LO** or **HI** while the warm zone is active.
3. When finished, press **ON/OFF** to turn the warm zone off.

WARM ZONE Temperature Selection

If a particular food is not listed, start with the medium heat level and adjust as needed (See [Table 2](#)). Most foods can be kept at serving temperatures by using the medium heat level.

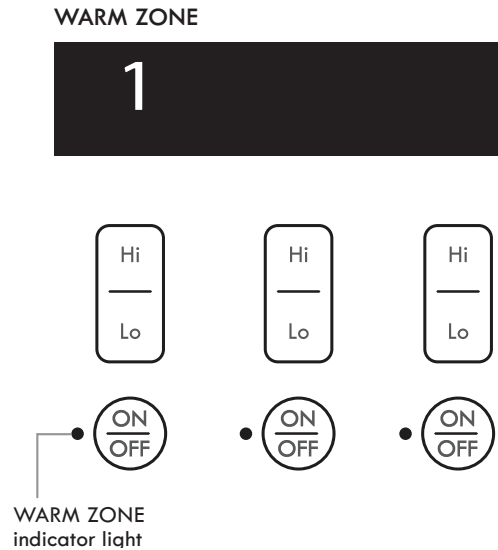

Figure 13: WARM ZONE control set for LO (1)

Table 2: WARM ZONE recommended food settings

Food Item	Heating Level
Breads/Pastries	LO (1 Low)
Casseroles	LO (1 Low)
Dinner Plates with Food	LO (1 Low)
Eggs	LO (1 Low)
Gravies	LO (1 Low)
Meats	MED (2 Medium)
Sauces	MED (2 Medium)
Soups (cream)	MED (2 Medium)
Stews	MED (2 Medium)
Vegetables	MED (2 Medium)
Fried Foods	HI (3 High)
Hot Beverages	HI (3 High)
Soups (liquid)	HI (3 High)

Before Setting Oven Controls

Oven Vent Location

The oven vent is located under the control panel (Figure 14). When the oven is on, warm air passes through this vent. Steam or moisture may appear near the oven vent, this is normal. This venting is necessary for proper air circulation in the oven and good baking results. **Do not block oven vent:**



Figure 14: Oven vent location

CAUTION Always use pot holders or oven mitts when using the oven. When cooking, the oven interior and exterior, oven racks and cooktop will become very hot which can cause burns.

CAUTION Protective Liners — Do not use aluminum foil to line the oven bottom, racks, walls or any part of the oven. Only use aluminum foil as recommended in this manual. Improper installation of these liners may result in risk of electric shock, or fire.

CAUTION Remove all racks before using the self clean function.

Removing, replacing, and arranging flat or offset oven racks

- **To arrange** - Always arrange the oven racks when the oven is cool (prior to operating the oven).
- **To remove** - Pull the oven rack straight forward until it reaches the stop position. Lift up front of oven rack slightly and slide out.
- **To replace** - Place the oven rack on the rack guides on both sides of oven walls. Tilt the front of oven rack upward slightly and slide the oven rack back into place. Be sure oven racks are level before using the oven.

Types of Oven Racks

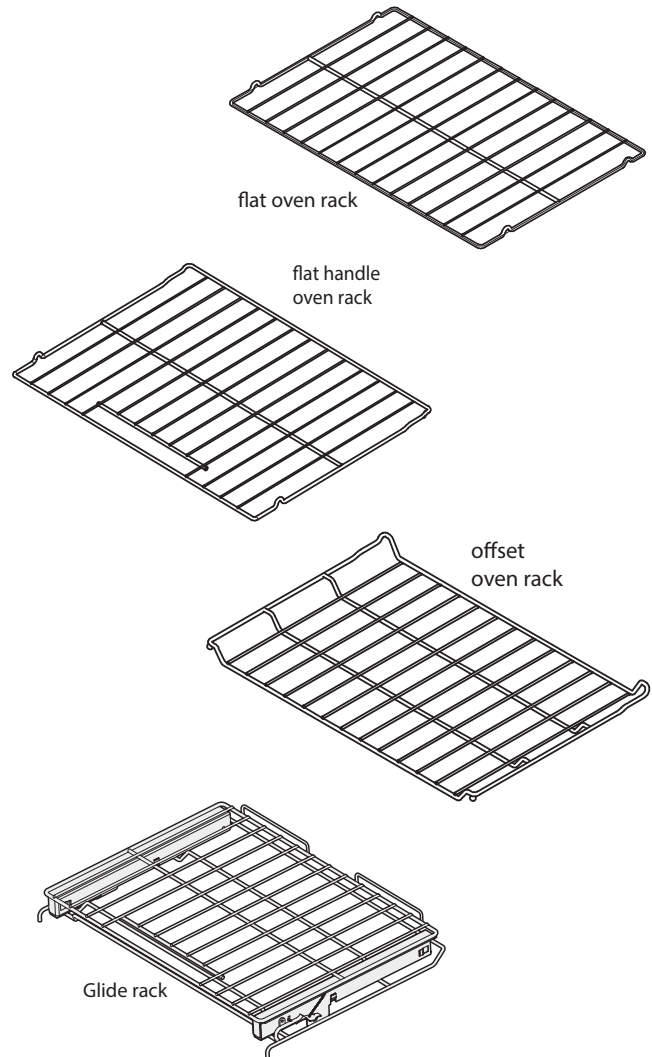

Figure 15: Variety of oven racks

- The flat oven rack (some models) or flat handle oven rack (some models) may be used for most cooking needs.
- The offset oven rack (on some models) is designed to place the base of the rack about 1/2 of a rack position lower than flat oven racks.
- Some models come with a Glide rack which has unique features and must be removed and replaced following specific instructions as shown on page 16.

Before Setting Oven Controls

The **Glide** rack (some models) allows you to easily slide bakeware in and out to check food or to remove or place items while firmly holding even heavier items in place. The rack will not extend beyond the glide stop position unless it is released manually.

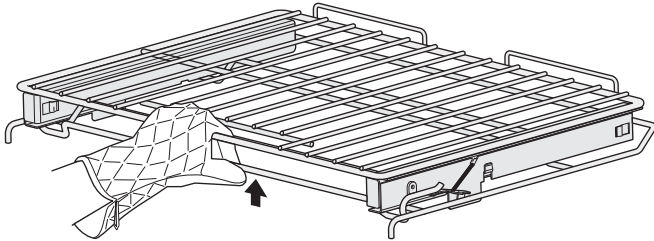

Figure 16: Releasing Glide rack lock

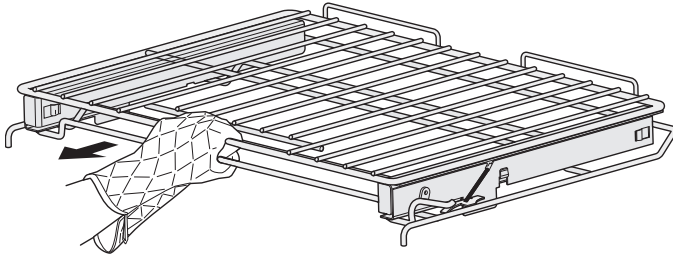

Figure 17: Pulling Glide rack to stop position

To remove the Glide rack for cleaning or a self clean cycle.

1. Grasp the locking bar beneath the handle as shown in [Figure 16](#). Pulling up on this bar unlocks the rack.
2. When the lock is released, pull the rack towards you until it stops ([Figure 17](#)).
3. Grasp the Glide rack on both sides and gently lift it up to allow the rack to move past the stop position ([Figure 18](#)) and remove the rack. When replacing the rack into the oven, set the Glide rack into the desired rack position by using the directions in step 3 in reverse.

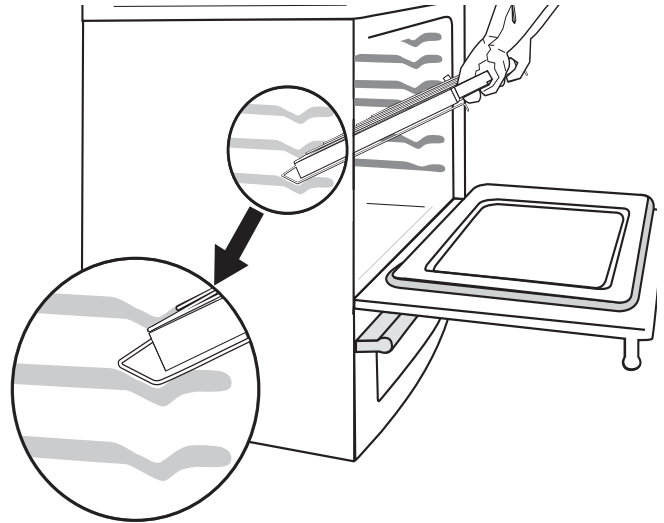

Figure 18: Correct angle to remove or insert the Glide rack.

Air circulation in the oven

For best air circulation when baking, allow a space of 2 inches (5 cm) around the bakeware for proper air circulation. Be sure pans and bakeware do not touch each other, the oven door, sides, or back of the oven cavity.

Hot air must be able to circulate around bakeware for even heat to reach the food.

Setting Oven Controls

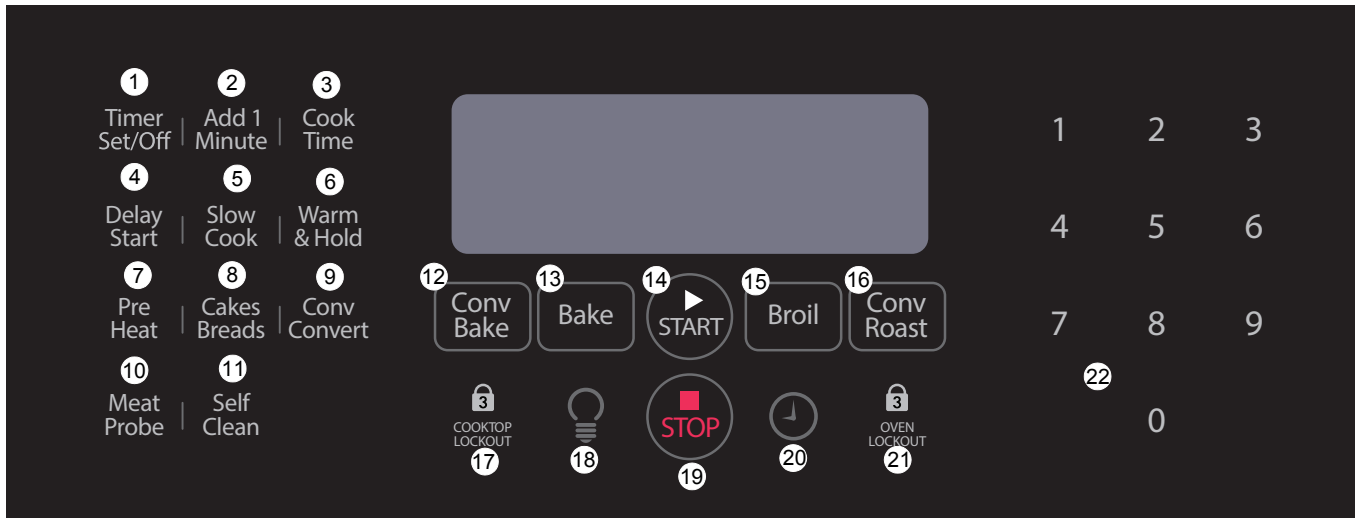

1. **Timer Set/Off** - Use to set and cancel timer.
2. **Add 1 Minute** - Each press of this key adds one minute of time to an active timer or will start timer when timer is idle.
3. **Cook Time** - Use to set a specific amount of time needed for cooking.
4. **Delay Start** - Use to set delay cooking or delay self clean.
5. **Slow Cook** - Use for cooking foods requiring long cooking times at lower temperatures.
6. **Warm & Hold** - Use to keep cooked food warm in the oven for up to 3 hours after cooking.
7. **Pre Heat** - Use to bring oven to desired temperature for cooking.
8. **Cakes Breads** - Use for baking bread and pastries.
9. **Conv Convert** - Use to convert regular recipe temperature to a convection recipe temperature.
10. **Meat Probe** - Use to set for cooking with probe feature.
11. **Self Clean** - Use to select the self clean function.
12. **Conv Bake** - Use to cook with convection feature.
13. **Bake** - Use to select normal baking function.
14. **START** - Use for starting all cooking functions
15. **Broil** - Use to select broiling function.
16. **Conv Roast** - Use for roasting hams, turkey, roasts.
17. **Cooktop Lockout** - Use to lock surface controls.
18. **Oven Light** - Use to turn oven light ON and OFF.
19. **STOP** - Use to stop any cooking function.
20. **Clock** - Use with numeric keys to set the time of day.

21. **Oven Lockout** - Use to lock oven door and control panel.
22. **Numeric keys** - Use to enter temperatures and cooking times, and use to enter time of day when setting clock.

Minimum & Maximum Control Settings

All of the cooking features listed have minimum and maximum time and temperature settings. An error tone (3 short beeps) will sound if the temperature or time is below the minimum or above the maximum setting for the cooking feature.

Table 3: Minimum and maximum control settings

Feature	Min. Temp. or Time	Max. Temp. or Time
Pre Heat	170°F (77° C)	550°F (288°C)
Bake	170°F (77° C)	550°F (288°C)
Broil	400°F (205°C)	550°F (288°C)
Cakes/Breads	170°F (77° C)	550°F (288°C)
Timer	1 Min	11 Hr 59 Min
Self Clean	2 Hours	4 Hours
Conv Bake	170°F (77° C)	550°F (288°C)
Conv Roast	170°F (77° C)	550°F (288°C)
Slow Cook	LO 225°F (108°C)	HI 275°F (134°C)
Warm & Hold	170°F (77° C)	3 hours
Cook Time	1 Min.	11:59
Delay time 12hr	1:00	12:59
Delay time 24hr	0:00	23:59
Clock 12hr	1:00	12:59
Clock 24hr	0:00	23:59

Setting Oven Controls

Setting The Clock

When the appliance is first powered up, **12:00** will flash in the display (Figure 19). The time of day must first be set before operating the oven.



Figure 19: 12:00 in display before setting clock

To set clock to 1:30:

1. Press **Set Clock**.
2. Enter **1 3 0** using numeric keys.
3. Press .

Important note:

The clock cannot be changed when a Cook Time, Self Clean, Delay Start or cooking feature is active.

- When timer is set for more than 1 hour it will display hours and minutes until 1 hour remains. When less than 1 hour remains, the display counts down in minutes and seconds. With less than 1 minute remaining, only seconds will display.
- If the timer is active during a cooking process, the timer will show in the display. To view the status of any other active oven function, press the key of the cooking function once and it will appear in the display for a few seconds.

Setting 12 hour or 24 hour display mode

The clock display mode allows you to select 12 hr or 24 hr modes. The factory pre-set clock display mode is 12 hours.

To set 12 hr or 24 hr display mode:

1. Press and hold **Set Clock** for 6 seconds.
2. Press **Self Clean** to toggle between **12 Hr day** or **24 Hr day** display modes. (Figure 20)
3. Press  to accept choice.



Figure 20: 12 Hr dAY and 24 Hr dAY settings

Changing Between Continuous Bake Setting or 12 Hour Energy Saving

The oven control has a factory preset built-in 12 Hour Energy Saving feature that will turn off the oven if the oven is left on for more than 12 hours. The control may be programmed to override this feature to bake continuously.

To change between continuous bake or 12 Hour Energy Saving feature:

1. Press and hold **Timer Set/Off** for 6 seconds
2. Press **Self Clean** to toggle between **12 Hour OFF** or **Stay On** (Figure 21) feature.
3. Press  to accept choice



Figure 21: 12 hr energy saving (L) and continuous setting (R)

Changing Oven Temperature Display

The oven control is preset for temperatures in °F (Fahrenheit) when shipped from the factory. The control can be changed to display either Fahrenheit or Celsius.

To change the display to F (Fahrenheit) or C (Celsius):

1. Press and hold **Broil** for 6 seconds.
2. Once **F (or C)** appears in the display, press **Self Clean** to toggle between Fahrenheit and Celsius temperature display modes.
3. Press  to accept choice.

Important note:

The oven temperature display cannot be changed during the cooking process or if a Delay Start has been set or Self Clean is active.



Figure 22: Display showing Fahrenheit and Celsius

Setting Silent or Audible Control mode

Silent mode allows the oven control to operate without audible tones. The control may be programmed for silent operation and later reset to operate with all the normal audible tones.

To set for silent or audible mode:

1. Press and hold **Delay Start** for 6 seconds.
2. Press **Self Clean** to toggle between **bEEP On** or **bEEP OFF**.
3. Press  to accept choice.



Figure 23: Display showing audible and silent operation

Setting Oven Controls Lockout

The control may be programmed to lock the oven door and lock the oven control keys.

To activate the oven lockout features:

1. Be sure oven door is completely closed.
2. Press and hold **Oven Lockout** for 3 seconds. **door Loc** will appear in the display (Figure 24). The motor driven door latch mechanism will begin locking the oven door automatically. Do not open the oven door. Allow about 15 seconds for the oven door to completely lock. Once door is locked, **Loc** will appear in the display.



Figure 24: Display showing door locking and in locked position

To cancel the oven lockout feature:

1. Press and hold **Oven Lockout** for 3 seconds. The motor door latch will begin unlocking the oven door automatically. Do not open the oven door. Allow about 15 seconds for the oven door to completely unlock.
2. When the **Loc** message no longer displays, the oven door may be opened and the oven control keys will be available for use.

Important note:

- To avoid damage to the oven door latching mechanism, do not attempt to open or close the oven door whenever the **door Loc** message is displayed.
- If a control key is pressed when oven lockout is active, the control will triple beep indicating the key action is not available when the oven lockout feature is active.

Operating Oven Lights

The interior oven lights will automatically turn on when the oven door is opened.

Important note: The oven light will not operate during a self clean cycle.

Press  to turn the interior oven lights on and off whenever the oven door is closed.

The interior oven lights are located on the rear wall of the oven interior and are covered with a glass shield. The glass shield protects the bulb from high temperatures and should always be in place whenever the oven is in use.

To replace the interior oven light, see [“Replacing the oven light”](#) on page 37.

Setting Timer

The minute timer allows you to track your cooking times without interfering with the cooking process. The timer may be set from a minimum time of 1 minute to a maximum of 11 hours and 59 minutes.

To set timer for 5 minutes:

1. Press **Timer Set/Off**.
2. Enter **5** using numeric key.
3. Press  to start timer. When set time ends, **END** will show in the display and the control will sound a beep three times every 30 seconds until Timer Set/Off key is pressed.

To cancel the timer when active press **Timer Set-Off** again.

Important note:

- The timer does not start or stop the cooking process. It serves as an extra minute timer that will beep when the set time has run out. The timer may be used alone or while using any of the other oven functions.

Add 1 Minute

Use **Add 1 Minute** to set additional minutes to the timer. Each press of the key will add 1 minute. If **Add 1 Minute** is pressed when the timer is not active, the timer will activate and begin counting down from 1 minute.

To add 2 minutes to the timer:

Press **Add 1 Minute** twice.

Setting Oven Controls

Setting PreHeat

For best baking performance use the PreHeat feature. The Preheat feature will bring the oven up to the set cooking temperature. A reminder tone will sound indicating when the set temperature is reached and to place the food in the oven.

When the oven is finished preheating the preheat feature will perform like the Bake feature and continue to maintain the oven set temperature until cancelled.

Preheat may be set for any oven temperature between 170°F (77°C) to 550°F (288°C).

⚠ CAUTION Always use pot holders or oven mitts when using the oven. When cooking, the oven interior, oven exterior, oven racks and cooktop will become very hot which can cause burns.

To set PreHeat with default oven temperature of 350°F (177°C):

1. Press **PreHeat**.

2. Press .

To cancel preheating at anytime press .



Figure 25: Oven in preheat mode for baking

To set PreHeat to 450°F (232°C):

1. Press **PreHeat**.

2. Press **4 5 0 (2 3 2)** using numeric keys.

3. Press .

To cancel preheating at any time press .

Important note:

- When setting Bake or any cooking feature that preheats the oven (except Broil), the convection fan will turn on and stay on until the oven reaches set temperature.
- Preheating is not necessary when roasting meats or cooking casseroles.
- For batter and dough-based baked goods such as cakes, pastries, and breads, use the standard bake function or refer to “Cakes and Breads” on [page 22](#) for best results.

Setting Bake

Use the bake feature whenever the recipe calls for baking using normal temperatures. A reminder tone will sound indicating when the set bake temperature is reached and to place the food in the oven. During preheat the convection fan will run to help heat the oven to the set temperature. The fan will turn off once the set temperature is reached.

Bake may be set for any oven temperature between 170°F (77°C) to 550°F (288°C).

To set Bake for oven temperature of 425°F (218°C):

1. Press **Bake**.

2. Enter **4 2 5 (2 1 8)** using numeric keys.

3. Press .

To cancel Bake at any time press .

For best results:

- Fully preheat the oven before baking items like cookies, biscuits and breads.
- Dark or dull pans absorb more heat than shiny bakeware, resulting in dark or overbrowning of foods. It may be necessary to reduce the oven temperature or cook time to prevent overbrowning of some foods. Dark pans are recommended for pies. Shiny pans are recommended for cakes, cookies and muffins.
- Do not open oven door often. Opening the door will reduce the temperature in the oven and may increase cook time..

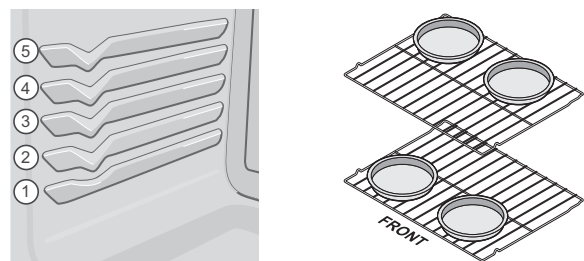

Figure 26: Rack positions and pan spacing recommendations

Radiant rack positions:

- When using any single rack, position the rack so that the food is in the center of the oven (position 3).
- If using the Glide rack, set one position lower than the flat or handle racks.
- For best results when baking cakes using 2 oven racks, place racks in positions 2 and 4. When baking using 2 oven racks, position bakeware as shown in [Figure 26](#). Allow at least 2 inches (5 cm) of space between bakeware for proper air circulation.

Setting Convection Bake

The convection function uses a fan to circulate the oven's heat uniformly and continuously around the oven (Figure 27). This improved heat distribution allows for fast, even cooking and browning results. It also gives better baking results when using two oven racks at the same time.

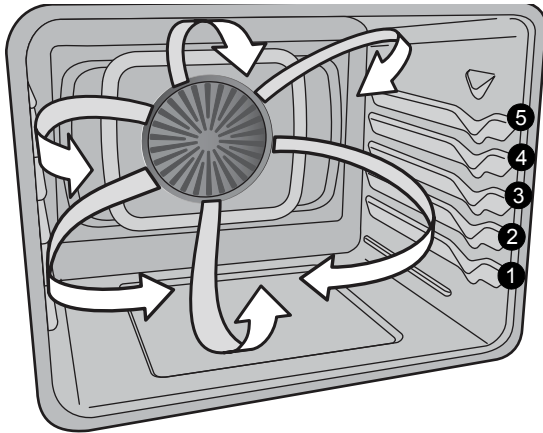

Figure 27: Air circulation in the convection function

Because most food items will cook faster and more evenly with the convection feature, it is advisable to reduce recipe's recommended temperature by 25° for best results. Follow the recipe's instructions using the minimum recommended cook time.

Convection Bake may be set for any oven temperature between 170°F (77°C) to 550°F (288°C).

Benefits of the convection bake feature:

- Foods may cook up to 25% faster, saving time and energy.
- Multiple rack baking.

For Best Results:

- Fully preheat the oven before baking items like cookies, biscuits and breads.
- For batter and dough-based baked goods such as cakes, pastries, and breads, use the standard bake function or refer to "Cakes and Breads" on page 22 for best results.
- Cookies and biscuits should be baked on pans with no sides or very low side to allow heated air to circulate around the food.
- Dark or dull pans absorb more heat than shiny bakeware resulting in dark or over browning of foods. It may be necessary to reduce the oven temperature or cook time to prevent over browning of some foods. Dark pans are recommended for pies. Shiny pans are recommended for cakes, cookies and muffins

To set Convection Bake with a default oven set temperature of 350°F (177°C):

1. Press **Conv Bake**.
2. Press **START**.

To cancel Convection Bake at any time press **STOP**.

Convection baking rack positions:

- When using any single rack, position the rack so that the food is in the center of the oven (position 3).
- If using the Glide rack, set one position lower than suggested positions for flat or handle racks.
- For best results when baking cakes using 2 oven racks, place racks in positions 2 and 4.
- When baking, allow at least 2 inches (5 cm) of space between bakeware for proper air circulation.

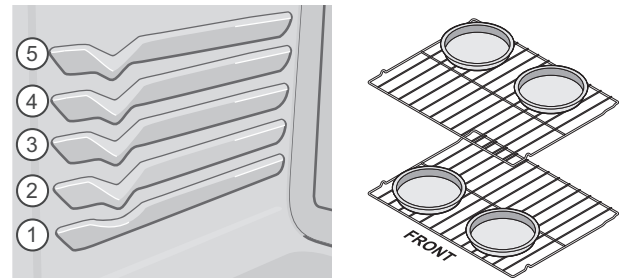

Figure 28: Convection rack positions and pan spacing

Note:

- The convection fan will begin rotating once Convection Bake, Convection Roast or Convection Convert has been activated.
- If the oven door is opened when the convection function is active, the convection fan will stop rotating until the oven door is closed.
- When using Convection Bake, cook time reductions may vary depending on the amount and type of food being cooked.
- Opening the oven door too often will allow heat to escape and extend the time needed for proper baking..

Setting Oven Controls

Setting Convection Convert



Pressing the **Conv Convert** key automatically converts the cooking temperature entered for any standard baking recipe to the lower temperature required for convection baking.

When Convection Convert is used with a timed Convection Bake setting of 20 minutes or more, the Convection Convert function will display a **CF** message (Figure 29) as a reminder to check food when the bake time is 75% complete. At this time the oven control will sound 1 long beep at regular intervals until the set cook time has finished.



Figure 29: Check Food reminder shown in display.

To program oven for Convection Convert with recipe temperature of 425°F (218°C) and to shut-off after 30 minutes:

1. Press **Conv Bake**.
2. Enter **4 2 5 (2 1 8)** using numeric keys.
3. Press  to accept.
4. Press **Cook Time**.
5. Enter **3 0** using numeric keys.
6. Press  to accept.
7. Press **Conv Convert**. Set bake temperature will convert to a lower temperature and begin baking process.

To cancel Convection Convert at any time press .

Important note:

- When using Convection Convert feature Cook Time reductions may vary depending on the oven set temperature.
- The convection fan will begin rotating once Convection Bake, Convection Roast or Convection Convert has been activated.
- If the oven door is opened when any convection function is active, the convection fan will stop rotating until the oven door is closed.

Cakes and Breads

The Cakes Breads functions are designed to give optimum baking performance for Cakes or Breads. These functions work well for baking cakes, brownies, pies (fresh or frozen), baked custards, cheesecakes, breads, rolls, biscuits, muffins and cornbread.

The Cakes function provides a preheat with a gentle cycling of heat giving cakes more volume and allowing delicate foods to cook more evenly.

The Breads function adds a special preheat feature to the bake cycle that thoroughly heats the oven from top to bottom to give more evenly browned foods.

To set the Cakes or Breads features with a default temperature of 350°F (177°C):

1. Arrange interior oven racks when cool. Preheat oven as desired and place food in oven.
2. For Cakes, press the **Cakes Breads** until **CAKES** appears in the oven control display. For Breads, press the **Cakes Breads** until **BREADS** appears in the oven control display
3. Press .



Figure 30: Oven set for Cake baking



Figure 31: Oven set for Bread baking

Important note:

- Dark or dull pans and glass absorb more heat than shiny bakeware resulting in dark, over browned, or under cooked foods. To prevent this it may be necessary to reduce the oven temperature or cook time of some foods.
- Do not open the oven door too often. Opening the door will reduce the temperature in the oven.
- Breads will have better results baking on a single oven rack.
- Layer cakes will have best results using the Cakes function.



Baking layer cakes with 1 or 2 oven racks

For best results when baking cakes or cookies using 2 oven racks, place cookware on rack in positions 2 and 4. For best results when baking cakes or cookies using a single oven rack, place offset oven rack in position 3.

Setting Cook Time

Use **Cook Time** to program the oven control to automatically turn the oven function off after a desired length of time.

To program oven to bake with oven default temperature of 350°F (177°C) and to shut-off after 30 minutes:

1. Press **Cook Time**.
2. Enter **3 0** using numeric keys.
3. Press  to accept.
4. Press **Bake**.
5. Press .

When the programmed cook time ends:

End will appear in the display window and the oven will shut-off automatically (Figure 32). The oven control will beep 3 times every 30 seconds as a reminder until  is pressed.



Figure 32: Display showing cooking has ended

Important note:



- The Cook Time feature may be set with Bake, Convection Bake, Convection Roast, Slow Cook and Preheat. Cook Time will not operate with the Broil function.
- The maximum Cook Time setting is 11 hours and 59 minutes unless oven is set for continuous cooking.
- To check the time remaining during a timed cooking function, press the Cook Time key once and the time remaining will appear in the display momentarily.

Setting Delay Start

Delay Start sets a delayed starting time to oven cooking or cleaning functions. Prior to setting a delay start, be sure the time of day is set correctly.

⚠ WARNING Food poisoning hazard. Do not let food sit for more than one hour before or after cooking. Doing so can result in food poisoning or sickness. Foods that can easily spoil such as milk, eggs, fish, meat or poultry, should be chilled in the refrigerator first. Even when chilled, they should not stand in the oven for more than 1 hour before cooking begins, and should be removed promptly when finished cooking.

To program oven for a Delay Start beginning at 5:30, to shut-off automatically after 50 minutes and for baking at 375°F (190°C):

1. Press **Cook Time**.
2. Enter **5 0** using numeric keys.
3. Press  to accept.
4. Press **Delay Start**.
5. Enter **5 3 0** using numeric keys.
6. Press  to accept.
7. Press **Bake**.
8. Enter **3 7 5 (1 9 0)** using numeric keys.
9. Press .

When the programmed cook time ends:

End will appear in the display window and the oven will shut off automatically (Figure 32). The oven control will beep 3 times every 30 seconds as a reminder until  is pressed.

Important note:

- Delay Start may be set using a 24 hr clock. To set clock for 24 Hr operation See “[Setting 12 hour or 24 hour display mode](#)” on [page 18](#) for more information.
- The Delay Start feature may be used with Convection Bake, Convection Roast, Convection Convert, Bake, Slow Cook and Preheat functions and Self Clean. Delay Start or Cook Time will not operate with the Broil function.

Setting Oven Controls

Setting Broil

Use the broil function to cook meats that require direct exposure to radiant heat for optimum browning results. The Broil feature is factory preset to broil at 550°F. The Broil function temperature may be set at any temperature between 400°F (205°C) and 550°F (288°C).

The suggested broil settings table (Table 4) are recommendations only. Depending on cooking preferences you can increase or decrease cooking times or move food to a different rack position. If the food you are broiling is not listed in the table, follow the instructions provided in your cookbook and watch the item closely.

⚠ WARNING Should an oven fire occur, close the oven door and turn the oven off. If the fire continues, use a fire extinguisher. Do not put water or flour on the fire. Flour may be explosive.

⚠ CAUTION Always use pot holders or oven mitts when using the oven. When cooking, the oven interior, exterior, oven racks and oven will become very hot which can cause burns.

Important note:

- Always arrange oven racks when oven is cool.
- Be sure to close oven door when broiling.
- For best results when broiling, use quality broil pan along with a broil pan insert. A broil pan is designed to drain the fat from food, helping to reduce smoking and avoid splatter. Do not use the pan without the insert. Do not cover the insert with foil – the exposed grease could ignite.
- When broiling, always pull the oven rack out to the stop position before turning or removing food.

To set Broil with the default broil oven temperature of 550°F:

1. Arrange the oven racks when cool. For optimum browning results, preheat oven for 2 minutes before adding food.
2. Position bakeware in oven to the preferred rack position. (Figure 33).
3. Press **Broil**.
4. Press **START**.
5. Broil on one side until food is browned; turn and broil other side until done to your satisfaction.
6. When finished broiling press **STOP**.
7. To cancel Broil at any time press **STOP**.

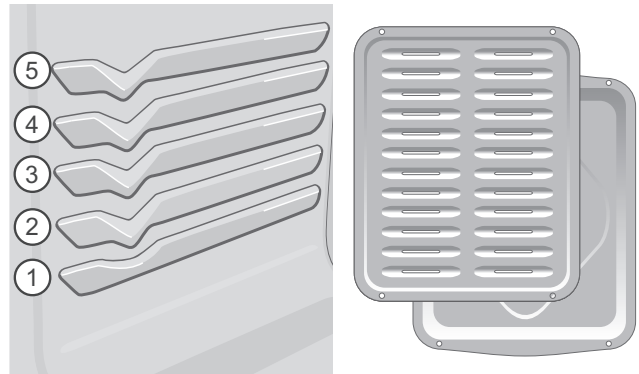

Figure 33: Broil rack positions and broil pan with insert

If a broiler pan and insert are not supplied with this appliance you may purchase them. Call Sears at 1-800-4-MY-HOME (1-800-469-4663) and order broiler pan kit 5304442087.

Table 4: Suggested Broil Settings

Food	Rack Position	Setting	Cook Time in minutes		Preparation
			1st side	2nd side	
Steak 1" thick	4th or 5th*	550°F/288°C	6	4	Medium
Steak 1" thick	4th or 5th*	550°F/288°C	7	5	Medium-well
Steak 1" thick	4th or 5th*	550°F/288°C	8	7	Well
Pork chops 3/4" thick	4th	550°F/288°C	8	6	Well
Chicken (bone in)	3rd	450°F/232°C	20	10	Well
Chicken (boneless)	3rd	450°F/232°C	8	6	Well
Fish	5th*	550°F/288°C	- as directed - - as directed -		Well
Shrimp	4th	550°F/288°C			Well
Hamburger 1" thick	5th*	550°F/288°C	9	7	Medium
Hamburger 1" thick	4th	550°F/288°C	10	8	Well

*Use the offset rack when broiling in the 5th position.

Setting Convection Roast

The Convection Roast function combines a cook cycle with the convection fan to roast meats and poultry. Meats cooked using the Convection Roast function will be juicier and poultry will be crisp on the outside while staying tender and moist on the inside.

Convection Roast may be set for any oven temperature between 170°F (77°C) to 550°F (288°C).

Suggestions for Convection Roast:

- Preheating is not necessary when roasting foods using Convection Roast. Since Convection Roast cooks food faster, reduce the cook time by 25% from the recommended cook time of your recipe. If necessary, increase cooking time until the desired doneness is obtained.
- The broiler pan will catch grease drippings, and the grid will help prevent splatters. The roasting rack will hold the meat. Use the offset rack on rack position 1.
- Do not cover foods when dry roasting as this will prevent the meat from browning properly.

To set Convection Roast with a default oven set temperature of 350°F (177°C):

1. Press **Conv Roast**.

2. Press .

To cancel Convection Roast at any time press .

Important note:

- The convection fan will begin rotating once Convection Bake, Convection Roast or Convection Convert has been activated.
- If the oven door is opened when any convection function is active, the convection fan will stop rotating until the oven door is closed.
- It is not recommended to roast chicken on a roasting rack. Use a deep pan instead and roast on rack position 1.

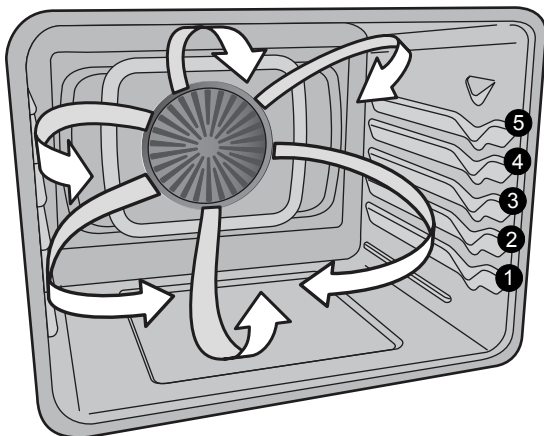

Figure 34: Air circulation in the convection function

Setting Slow Cook

The Slow Cook feature cooks foods more slowly and at lower oven temperatures for longer periods of time. Slow Cook is ideal for roasting beef, pork and poultry. Slow cooking meats may result in the exterior of meats becoming dark but will not burn the outside as it seals in the meat's juices.

Two Slow Cook settings are available, high (**Hi**) or low (**Lo**). The high setting is best for cooking foods between 4 and 5 hours. The low setting is best for cooking foods up to 9 hours or longer.

⚠ WARNING Food poisoning hazard. Do not let food sit for more than one hour before or after cooking. Doing so can result in food poisoning or sickness. Foods that can easily spoil such as milk, eggs, fish, meat or poultry, should be chilled in the refrigerator first. Even when chilled, they should not stand in the oven for more than 1 hour before cooking begins, and should be removed promptly when finished cooking.

Some tips for best results when using Slow Cook:

- Completely thaw all frozen foods before cooking.
- When using a single oven rack, place in oven rack position 2 or 3. Position racks to accommodate the size of various bakeware when cooking multiple food items.
- Do not open the oven door often or leave the door open when checking foods. If the oven heat escapes often, the Slow Cook time may need to be extended.
- Cover to keep foods moist or use a loose or vented type cover to allow foods to turn crisp or brown.
- Roasts may be left uncovered so browning can occur. Cook times will vary depending on the weight, fat content, bone, and the shape of the roast. Preheating the oven will not be necessary when using the Slow Cook feature.
- Add any cream or cheese sauces during the last hour of cooking.

To set Slow Cook:

1. Position bakeware in oven and close oven door.
2. Press **Slow Cook**. **Hi** will appear in the display indicating the default temperature setting is for high.
3. If a low setting is needed, press **Slow Cook** again to select the low setting.

4. Press  to activate Slow Cook.

To cancel Slow Cook at any time press .

Important note:

- Slow Cook may be used with additional settings of Cook Time and Delay Start.
- The maximum cook time for Slow Cook function is 11 hours and 59 minutes unless the control has been changed to the continuous bake mode.

Setting Oven Controls

Meat Probe

When cooking meat such as roasts, hams or poultry, use the meat probe function to check the internal temperature without any guesswork. For some foods, especially poultry and roasts, testing the internal temperature is the best method to insure properly cooked meats.

Important note:

- Use **ONLY** the meat probe supplied with appliance. Using any other probe or device may result in damage to appliance and the meat probe receptacle.
- Never leave or store meat probe inside oven.
- Handle the meat probe carefully when inserting and removing from food or probe receptacle. Do not use tongs to pull on meat probe cable when inserting or removing from food or receptacle.
- Defrost food completely before inserting meat probe to avoid damaging probe.
- To avoid possibility of burns, after cooking carefully unplug meat probe using a pot holder to protect hands.

Proper meat probe placement:

Always insert meat probe so that the probe tip rests in the center of the thickest part of meat. Do not allow meat probe to touch bone, fat, gristle or cookware.

For bone-in ham or lamb, insert meat probe into the center of lowest large muscle or joint. For dishes such as meat loaf or casseroles, insert meat probe into center of food. When cooking fish, insert meat probe just above the gill.

For whole poultry or turkey, insert meat probe into the thickest part of inner thigh, below the leg (Figure 35).

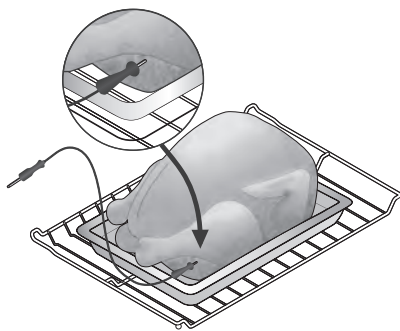





Figure 35: Probe into thickest part of thigh

Important note:

Changing how the oven reacts after reaching the target temperature must be done before starting the cooking process.

To set meat probe:

1. Prepare the food and properly insert the temperature probe into the food. Do not preheat or start cooking before properly inserting the meat probe. Probe should be inserted into the food and receptacle while the oven is still cool.
2. Place the prepared food on the desired oven rack position and slide into the oven.
3. Plug the meat probe into the probe receptacle located on the top left side of oven cavity.
4. To set the target temperature press **Meat Probe** once then enter the desired target internal temperature using the numeric key pads (default setting is 170°F/ 77°C). Press  to accept the meat probe target temperature. Close the oven door.
5. Set the oven control for Bake, Convection Bake or Convection Roast and the desired oven temperature. The meat probe cannot be set with Broil or Self-Clean.
6. While cooking, the actual meat probe temperature will display by default. To view the target temperature press **Meat Probe** once. After 6 seconds the display will show the actual meat probe temperature. If the target temperature needs to be changed during the cooking process, press **Meat Probe** once and use the numeric keys to adjust the target temperature. Press  to accept any change.
7. The oven control will provide 3 beeps when the internal target temperature is reached. The oven will automatically change to a **Warm & Hold** setting and maintain the oven temperature at 170° F (77°C). Instructions for changing how the oven reacts after reaching the internal target temperature may be found later in this section.
8. Press  to cancel cooking at any time.

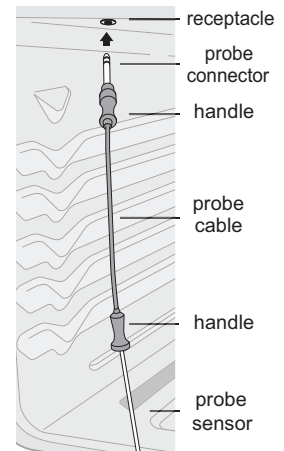

To set the oven to continue cooking after reaching the probe target temperature:

1. Press **Meat Probe** and hold for 6 seconds.
2. Press **Self Clean** and toggle until the **Continu** message appears then press  to accept.

To set the oven to cancel cooking and automatically start Warm & Hold after reaching the probe target temperature:

1. Press **Meat Probe** and hold for 6 seconds.
2. Press **Self Clean** and toggle until **CANCEL** message appears then press  to accept.



Figure 36: Probe set to continue cooking



Figure 37: Probe set to cancel cooking

Minimal Internal Cooking temperatures

Food type	Internal temperature
Beef, veal, lamb-roasts, steak & chops	
Medium	160°F (71°C)
Well done	170°F (77°C)
Fresh pork-roasts, steaks & chops	
Medium	160°F (71°C)
Well done	170°F (77°C)
Ham	160°F (71°C)
Poultry	
Whole chicken, turkey	165°F (74°C)
Poultry breasts, roasts	165°F (74°C)
Stuffing (cooked alone or in bird)	165°F (74°C)
Leftovers	165°F (74°C)

Information courtesy the U.S. Department of Agriculture Food Safety and Inspection Service.

The U.S. Department of Agriculture states, "Rare fresh beef is popular, but you should know that cooking it to only 140°F/60°C means some food poisoning organisms may survive." (Source: Safe Food Book, Your Kitchen Guide, USDA Rev. June 1985.) The lowest temperature recommended by the USDA is 145°F/63°C for medium rare fresh beef.

Warm & Hold

⚠ WARNING Food poisoning hazard. Do not let food sit for more than one hour before or after cooking. Doing so can result in food poisoning or sickness



Warm & Hold should only be used with foods that are already at serving temperatures. Warm & Hold will keep cooked foods warm and ready for serving for up to 3 hours after cooking has finished. After 3 hours the Warm & Hold will shut-off automatically. Warm & Hold will keep the oven temperature at 170° F (77°C).

To set Warm & Hold:

1. If needed, arrange oven racks and place cooked food in oven.
2. Press **Warm & Hold**. **Hld** will appear in the display. If no other keys are touched within 25 seconds the request for Warm & Hold will clear.
3. Press . Warm & Hold will automatically turn on and then turn off after 3 hours unless cancelled.

To turn Warm & Hold off at any time press .

To add Warm & Hold to turn ON after baking 45 minutes with a set temperature of 425°F (218°C):

1. Press **Cook Time**.
2. Enter **4 5** using numeric keys.
3. Press .
4. Press **Bake** and enter **4 2 5 (2 1 8)** on numeric keys.
5. Press  to accept.
6. Press **Warm & Hold**. **Hld** will appear in the display.
7. Press  to accept. When the cook time is over, the Warm & Hold will automatically turn ON. The Warm & Hold function will automatically turn OFF after 3 hours.

Important note:

- Warm & Hold will maintain the oven temperature at 170° F (77°C) for 3 hours.
- Warm & Hold may be set when finished cooking or may be added to automatically turn on after cooking using Cook Time. Delay Start may also be added.

Setting Oven Controls

Warmer Drawer

The purpose of the warmer drawer is to keep hot cooked foods at serving temperature. Use the warmer drawer feature to keep cooked foods hot such as vegetables, gravies, casseroles, soups, stews, breads, pastries and oven safe dinner plates at serving temperature.

Important: Always start with hot food. Do not heat cold food with the warmer drawer. All food placed on the warmer drawer should be covered with a lid to maintain quality. For best results, when warming pastries or breads, the cover should have an opening to allow moisture to escape. Use only dish ware, utensils and cookware recommended for oven and cooktop use in the warmer drawer.

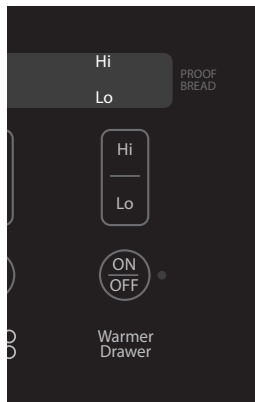

Figure 38: Warmer Drawer with three heat settings

1. Press **Warmer Drawer**. The warmer drawer indicator light will turn on.
2. Press **LO** for the lowest setting.

Important: Pressing **LO** twice will activate “Proof Bread (Warmer Drawer)” feature as explained on [page 29](#).

3. Press **HI** once to set a medium temperature. Press **HI** again for the highest heat setting. The warmer drawer indicator light will also stay lit until the warm drawer is turned off.
4. When ready to serve, press the **warmer drawer** key until the indicator light is **OFF**.

⚠ WARNING Food poisoning hazard. Do not let food sit for more than one hour before or after cooking. Doing so can result in food poisoning or sickness.

Arranging Warmer Drawer Rack Positions

The warmer drawer rack can be set in two positions to accommodate foods and any items that need to be warmed or kept warm. The rack must be placed in the vertical position in one of two ways.

In the upright position ([Figure 39](#)) to allow low profile food items to be placed both under and on top of the rack (for example, rolls or biscuits on top of the rack and a casserole dish under).

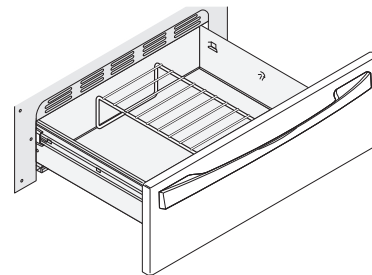

Upright Position

Figure 39: Warmer Drawer in upright position

In the downward position ([Figure 40](#)) to allow the placement of light weight food items and empty dish ware (for example, rolls or pastries and dinner plates).

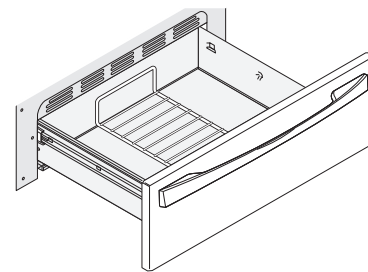

Downward Position

Figure 40: Warmer Drawer in downward position

Important notes:

- Use only plates, utensils and cookware recommended for oven and ceramic cooktop use. Do not use plastic wrap or aluminum foil to cover food. Plastic or aluminum foil can melt onto the cooktop.

Warmer Drawer Settings

Refer to the warmer drawer recommended food settings below. If a particular food is not listed, start with the medium level, and adjust as needed.

Table 5: Suggested settings for Warmer drawer

Food Item	Heating level
Breads/ Pastries	LO
Casseroles	LO
Dinner Plates with food	LO
Eggs	LO
Gravies	LO
Meats	MED
Sauces	MED
Soups (Cream)	MED
Stews	MED
Vegetables	MED
Fried foods	HI
Hot beverages	HI
Soups (clear)	HI

CAUTION Do not place flammable items such as plastic salt and pepper shakers, spoon holders or plastic wrappings on top of the range when it is in use. These items could melt or ignite. Potholders, towels or wooden spoons could catch fire if placed too close to the surface elements. Do not allow aluminum foil, empty glass-porcelain cookware or any material that can melt to make contact with the ceramic cooktop.

Proof Bread (Warmer Drawer)

The warmer drawer has a Proof Bread feature that may be used to prepare bread dough. The recommended length of time to keep fresh or thawed bread dough in the warmer drawer is about 45-60 minutes. Times may vary depending on the dough. Be sure to follow the recipe's recommended times.

Since the bread dough will nearly double in volume be sure to place the prepared dough in a large bowl. Arrange the warmer drawer rack in the downward position (Figure 41) and place the bowl with dough on the warmer drawer rack.

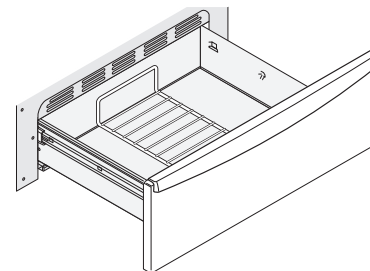

Figure 41: Warmer drawer rack down for proofing bread

To set Proof Bread using warmer drawer:

1. Arrange the warmer drawer rack in warmer drawer and place bread dough in a large bowl on warmer drawer rack. Close warmer drawer.
2. Press **ON-OFF** to turn on warmer drawer.
3. Press **Lo** once set warmer drawer to low power setting.
4. Press **Lo** again and the **Proof Bread indicator light** will turn on. This is the automatic setting for using the Proof Bread feature.
5. When the bread dough is ready, press **ON-OFF** to turn the warmer drawer off and remove bread dough from warmer drawer.



Figure 42: Use Warmer Drawer control to set Proof Bread

Setting Oven Controls

Setting the Sabbath feature (for use on the Jewish Sabbath and Holidays)



For further assistance, guidelines for proper usage and a complete list of models with the Sabbath feature, please visit the web at www.star-k.org.

This appliance provides special settings for use when observing the Jewish Sabbath/Holidays. Sabbath mode disables all audible tones or visual display changes on the oven control. Bake heating is the only cooking feature available while in the Sabbath mode. Oven controls are locked during Sabbath mode.

You must first set the Bake feature and temperature(s) needed for the oven, and the Cook Time and Delay Start options (if needed). Any settings made prior to setting the Sabbath mode will be visible in the displays. The Cook Time option, if set prior to the Sabbath mode, will give one audible alert at the end of Cook Time.

The Sabbath mode will override the factory preset 12 Hour Energy Saving mode and the appliance will stay on until the cooking features are cancelled. If any of the cooking features are cancelled when the appliance is in the Sabbath mode, no audible or visual indicators will be available to verify the cancellation.

During Sabbath all cooking zones will be locked and dashes will be shown on all surface displays.

If the oven interior lights are needed, be sure to activate them prior to setting the Sabbath mode. Once the oven light is turned on and the Sabbath mode is active, the oven light will remain on until the Sabbath mode is turned off and the oven lights are turned off. The oven door will not activate the interior oven lights when the oven door is opened or closed.

It is recommended that any oven temperature modification made within an active Sabbath mode be followed with 2 presses of the **START** key. This will insure the oven remains on even if an attempt is made to set the oven temperature outside of its temperature range. If the oven temperature is set outside of the temperature range, the oven will default to the nearest available temperature. Try to set the desired oven temperature again.

⚠ WARNING Food poisoning hazard. Do not let food sit for more than one hour before or after cooking. Doing so can result in food poisoning or sickness. Foods that can easily spoil such as milk, eggs, fish, meat or poultry, should be chilled in the refrigerator first. Even when chilled, they should not stand in the oven for more than 1 hour before cooking begins, and should be removed promptly when finished cooking.

To program oven to Bake with default oven temperature of 350°F and activate the Sabbath feature:





1. Be sure the clock is set with the correct time of day.
2. Arrange oven racks, place bakeware in oven and close oven door.
3. Press **Bake**.
4. Press .
5. If Cook Time or Delay Start are not needed, skip this step and continue to step 6. If a Cook Time or Delay Start are desired enter the times at this point. Refer to the “[Setting PreHeat](#)” and “[Setting Bake](#)” on [page 20](#) for detailed instructions.
6. Press and hold **Cook Time** and **Delay Start** simultaneously for about 3 seconds to set the Sabbath feature. Once the feature is set, **SAb** ([Figure 43](#)) will appear in the display indicating the oven is properly set for the Sabbath feature.



Figure 43: Oven set for Sabbath baking.

Important note:

- Do not attempt to activate any other oven function except Bake while the Sabbath feature is active. The following keys will function correctly when the Sabbath feature is active: 0-9 number keys, Bake,  and . All other keys should not be used once the Sabbath feature is active.
- You may change the oven temperature once baking has started. Press **Bake**, use the numeric keys to enter the oven temperature change (170°F to 550°F) and press  (for Jewish Holidays only).
- Remember that the oven control will no longer provide audible tones or display any further changes when the Sabbath feature is active.
- Remember the oven will shut-off automatically after completing a Cook Time, Delay Start or Warm & Hold and therefore may only be used once during the Sabbath/Jewish Holidays.
- If a Delay Start time longer than 11 hours and 59 minutes is desired, set the oven control for the 24 hour day display mode setting. For detailed instructions see “[Setting 12 hour or 24 hour display mode](#)” on [page 18](#).

To turn the oven off and keep the Sabbath feature active:

Press .

To turn off the Sabbath feature:

Press and hold both **Cook Time** and **Delay Start** simultaneously for at least 3 seconds to turn the Sabbath feature off. The control will provide an acceptance tone and **SAb** will disappear from the display. The oven is no longer programmed for the Sabbath feature.

What to do during a power failure or power interruption after the Sabbath feature was activated:

Should you experience a power failure or interruption, the oven will shut-off. When power is restored the oven will not turn back on automatically. The oven will remember that it is set for the Sabbath and the oven display will show the message **SF** for Sabbath failure (Figure 44).

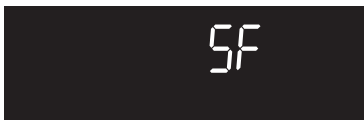

Figure 44: Display showing Sabbath failure

The food may be safely removed from the oven while still in the Sabbath feature, however the oven cannot be turned back on until after the Sabbath/Holidays. After the Sabbath observance turn off the Sabbath feature. Press and hold both Cook Time and Delay Start keys for at least 3 seconds simultaneously to turn the Sabbath feature off. SF will disappear from the display and the oven may be used with all normal functions.

Restoring Factory Default Settings

Your appliance was set with predetermined (default) oven control settings. The following options may have been modified since the appliance was new:

- 12 or 24 hr display mode
- Continuous bake or 12 Hour Energy Savings mode
- Silent or audible control
- Oven temperature display (Fahrenheit or Celsius)
- Oven temperature adjustments (UPO)
- Any stored recipe will be erased

To restore oven control to factory default settings:

⚠ CAUTION If you choose to restore any of the options by using this method, all user settings will be restored to the factory default settings. This includes the oven temperature offset that will reset to (0) zero.

1. Press and hold **7** on numeric keys until acceptance tone sounds (about 6 seconds).
2. Press . The control has been reset with the default settings.

Setting Oven Controls

Adjusting Oven Temperatures

Your appliance has been factory calibrated and tested to ensure accurate baking temperatures. For the first few uses, follow your recipe times and temperature recommendations carefully. If you think the oven is cooking too hot or too cool for your recipe times, you may adjust the control so the oven cooks hotter or cooler than the oven temperature displayed. The oven temperature may be increased as much as +35°F (+19°C) or decreased -35°F (-19°C) from the factory calibrated settings.

To increase (+) or decrease (-) the oven temperature by 20°F:

1. Press and hold **Bake** for about 6 seconds. The factory offset temperature of **0 (zero)** should appear in the display.
2. Enter **2 0** using numeric keys.
3. Press **Self Clean** to toggle between plus (+) if increasing temperature or minus (-) if decreasing the temperature.
4. Press  to accept change.

Important note:



- Oven temperature adjustments will not change the Broil or Self Clean function temperatures.
- If the temperature shows an adjustment of -20°F, and a +20°F adjustment is needed, toggle between the (±) in the display by pressing the Self Clean key.
- Do not use oven thermometers such as those found in grocery stores to check the temperature settings inside your oven. These oven thermometers may vary as much as 20 to 40°F degrees from actual temperatures.

Recipe Recall

Use the Recipe Recall feature to record and recall your favorite baking recipe settings. This feature stores and recalls different recipe settings using Bake, Conv Bake, and Conv Roast.

Recipe Recall may be programmed for any baking temperature between 170°F (77°C) to 550°F (288°C).

To store a Bake recipe. The recipe in this example is for a Bake at 325°F (162°C) with a cook time of 45 minutes:

1. Press **Bake**.
2. Press **3 2 5 (1 6 2)** using the numeric keys to enter oven temperature.
3. Press .
4. Press **Cook Time**.
5. Press **4 5** using numeric keys to enter cook time.
6. Press and hold  until a tone sounds (about 3 seconds). The tone indicates that the recipe setting has been recorded for future recall.
7. Press .

Important note: The oven will automatically start heating with the recorded recipe unless  is pressed at this time.

To recall recipe stored in the example shown above. Recipe is for bake at 325°F (162°C) for 45 minutes:

1. Position cookware in oven and close door.
2. Press **Bake**. (If recipe was stored using another cooking feature press that instead.).
3. Press . The oven will begin to cook with the programmed recipe. If Cook Time was recorded this feature will also recall the cooking time.

To cancel Recipe Recall at anytime press .

To erase a stored recipe:

1. Press the function where the recipe is stored.
2. Press .
3. Press **Cook Time**, enter **0 (zero)** and hold **start key** for 3 seconds until you hear the acceptance tone.

Important note:

- The Recipe Recall stores **Bake, Conv Bake, Conv Roast, Slow Cook, Cakes Breads and Preheat settings**. This feature will not work with **Delay Start** settings.
- If a recalled recipe includes Cook Time the oven will automatically shut-off when the Cook Time is finished.

Self Clean

A self cleaning oven cleans with very high temperatures well above normal cooking temperatures. The high temperature eliminates soils completely or reduces them to a fine powdered ash you can wipe away afterwards with a damp cloth.

The Self Clean function allows you to set a cleaning time from 2 hours to 4 hours. A 3 hour cleaning time is recommended for normal cleaning, 2 hours for light cleaning, and 4 hours for heavy cleaning.

Read before starting Self Clean:

⚠ CAUTION Do not leave small children unattended near the appliance. During the self cleaning cycle, the outside of the oven can become very hot to touch and can cause burns.

⚠ CAUTION Do not line the oven walls, racks, bottom or any other part of the oven with aluminum foil. Doing so will destroy heat distribution, produce poor baking results and cause permanent damage to the oven interior. Aluminum foil will melt to the interior of the oven.

⚠ CAUTION The health of some birds is extremely sensitive to the fumes given off during the self cleaning cycle of any oven. Move birds to another well-ventilated room.

⚠ CAUTION Do not force the door open while self clean is active. This can damage the automatic door locking system. Use caution when opening the oven door after self cleaning. The oven may still be very hot and can cause burns. To avoid possible burns stand to the side of the oven when opening the oven door to allow hot air or steam to escape.

Important note:

Completely remove all oven racks and any accessories from oven cavity to avoid damage to oven racks. If the oven racks are not removed they may discolor.

- Remove all items from the oven including bakeware, utensils and any aluminum foil. Aluminum foil will not withstand high temperatures from a self clean cycle and will melt.
- Do not use oven cleaners or oven protective coatings in or around any part of the oven interior.
- Clean any soil from the oven frame, the door liner outside the oven door gasket and the small area at the front center of the oven bottom (Figure 45). These areas heat sufficiently to burn soil on. Clean using soap and water prior to starting Self Clean.
- Do not clean the oven door gasket (Figure 45). The woven material of the oven door gasket is essential for a good seal. Care should be taken not to rub, damage or remove the gasket. Do not use any cleaning materials on the oven door gasket. Doing so could cause damage to the door gasket.

- Remove any excessive build up caused by spills. Any spill on the oven bottom should be wiped up and removed before starting a self clean cycle. To clean, use hot, soapy water and a cloth. Large spill residue can cause heavy smoke or fire when subjected to high temperatures. Do not allow food spills with a high sugar or acid content (such as milk, tomatoes, sauerkraut, fruit juices or pie filling) to remain on the surface as they may leave a dull spot even after cleaning.



Figure 45: Oven door area to clean and not clean (gasket).

To set self clean:

1. Be sure the oven is empty and all oven racks are removed and oven door is completely closed.
2. Press **Self Clean**. A 3 hour clean time will appear in the display. To choose a different clean time. Press **Self Clean** and use the numeric keys to select any time between 2 and 4 hours. Once time is selected proceed to step 3.
3. Press  to activate Self Clean.

As soon as Self Clean becomes active, a motor driven lock mechanism will begin locking the oven door automatically and **door Loc** will appear in the display (Figure 46). Do not open the oven door when door Loc is displayed (allow 15 seconds for the lock mechanism to lock the oven). Once the oven door has locked, **CLn** will appear in the display indicating Self Clean has started.



Figure 46: Door locking (L) and active Clean (R) shown

Setting Oven Controls

When Self Clean is finished:

CAUTION Use caution when opening the oven door after self cleaning. The oven may still be very hot and can cause burns. To avoid possible burns stand to the side of the oven when opening the oven door to allow hot air or steam to escape. The oven bake and broil elements may appear to have cooled after they have been turned off. The elements may still be hot and burns may occur if these elements are touched before they have cooled."

1. **Cln** message will turn off and **Hot** will appear in display window (Figure 47).
2. Once the oven has cooled down (about 1 hour) and **Hot** is no longer displayed, the **door OPn** message will appear. When this message turns off the oven door may be opened.



Figure 47: Hot oven showing door still locked (L) door OPn message will flash while door is opening once oven has cooled

Important note: Attempting to force open the oven door before the **door OPn** message is gone from the display can ruin the motor door latch.



3. When the oven interior has completely cooled, wipe away any residue or powdered ash with a damp cloth or paper towel.

Important note:

- The kitchen area should be well ventilated. Use an open window, ventilation fan or exhaust hood during the first self clean cycle to help eliminate the normal odors associated the initial clean cycle.
- When the clean time finishes the oven door will remain locked until the oven has cooled sufficiently. In addition to the clean time that was programmed, allow about 1 hour for the oven to cool before opening the oven door. The Self Clean function will not operate when the oven lockout is active.

Setting Delay Start Self Clean

To start a delay Self Clean with default clean time of 3 hours and a start time of 9:00 o'clock:

1. Be sure the clock is set with the correct time of day, the oven is empty and ALL oven racks are removed. Be sure oven door is completely closed.
2. Press **Delay Start**.
3. Using numeric keys enter **9 0 0** for time to start.
4. Press  to accept
5. Press **Self Clean**.
6. Press .

If it becomes necessary to stop Self Clean when active:

1. Press .
2. If Self Clean has heated the oven to a high temperature, allow enough time for the oven to cool and the **door OPn** message to appear (Figure 47). When this message turns off the oven door may be opened.
3. Before restarting Self Clean, be sure to read important notes below.

Important note:

- When Self Clean is active you may check the amount of clean time remaining by pressing the Self Clean key once.
- If your clock is set with the (default) 12 hr display mode, the Delay Start for a Self Clean can only be programmed to start up to 11 hours and 59 minutes after the time showing in the display (be sure to set the clock to current time before programming a delay start). To set a Delay Start Self Clean to begin 12 or more hours (maximum is 23 hours and 59 minutes) after the time of setting, be sure to first set the control in the 24 Hr display mode.
- If Self Clean was active and then interrupted by a power failure or cancelled before the oven was thoroughly cleaned, it may be necessary to run another Self Clean cycle.
- If the oven temperature was high enough when Self Clean was interrupted the oven control may not allow another Self Clean cycle to be set for up to 4 hours.

Care and Cleaning

Cleaning Various Parts of Your Oven

Before cleaning any part of the oven, be sure all controls are turned off and the oven is cool. Remove spills and any heavy soiling as soon as possible. Regular cleaning will reduce the difficulty of major cleaning later.

Surface Type	Recommendation
Aluminum and Vinyl Painted body parts Painted decorative trim	Use hot, soapy water and a cloth. For more difficult soils and built-up grease, apply a liquid detergent directly onto the soil. Leave on soil for 30-60 minutes. Rinse with a damp cloth and dry. Do not use abrasive cleaners on any of these materials; they can scratch.
Oven control panel Control membrane Decorative trim (some models)	Before cleaning the control panel, turn all controls off, activate oven lockout. Do not use abrasive cleaners on any of these materials; they can scratch. Clean using hot, soapy water and a cloth or sponge. Be sure to squeeze excess water from cloth or sponge before wiping control panel, especially when wiping around the controls area. When rinsing, use clean water and a cloth or sponge and be sure to squeeze excess water from cloth or sponge before wiping the control panel.
Easy Clean™ Stainless Steel (some models)	Always rub in direction of metal grain to avoid damaging. Do not use cleaners with high concentrations of chlorides or chlorine. Do not use harsh scrubbing cleaners. Polish with a lint free cloth. Always be sure to wipe excess cleaner/polish off from the metal surface as bluish stains may occur during future oven heating that cannot be removed. Clean heavier soils with hot, soapy water and a cloth or sponge. Rinse and dry using clean water and a cloth.
Stainless Steel (some models)	Only use cleaners and polishes that are specifically manufactured for cleaning stainless steel. Always rub in direction of metal grain to avoid damaging. Do not use cleaners with high concentrations of chlorides or chlorine. Do not use harsh scrubbing cleaners. Polish with a lint free cloth. Always be sure to wipe excess cleaner/polish off from the metal surface as bluish stains may occur during future oven heating that cannot be removed. Clean heavier soils with hot, soapy water and a cloth or sponge. Rinse and dry using clean water and a cloth.
Porcelain enamel broiler pan and insert (available by mail order) Porcelain parts Door liner and body parts	Gentle scouring with a soapy scouring pad will remove most spots. Rinse with a 1:1 solution of clear water and ammonia. If necessary, cover difficult spots with an ammonia-soaked paper towel for 30 to 40 minutes. Rinse with clean water and a damp cloth, and then scrub with a soap-filled scouring pad. Rinse and wipe dry with a clean cloth. Remove all cleaners or the porcelain may become damaged during future heating.
Oven racks	Oven racks must be removed from oven cavity. Clean by using a mild, abrasive cleaner following manufacturer's instructions. Rinse with clean water and dry.
Oven door	Use soap and water to thoroughly clean the top, sides, and front of the oven door. Rinse well. You may use a glass cleaner on the outside glass of the door. Do not immerse the door in water. Do not spray or allow water or the glass cleaner to enter the door vents. Do not use oven cleaners, cleaning powders, or any harsh abrasive cleaning materials on the outside of the oven door.
Cooktop Care and Cleaning	Be sure to read all information on how to care for your cooktop contained in the Cooktop Maintenance and Cooktop Cleaning sections starting on page 29.
Ceramic Cooktop	Do not use spray oven cleaners on the cooktop. See "Cooktop Maintenance" on page 36.
Cooktop surface burners and burner grates cleaning	Do not use a cooktop cleaner on a hot cooktop. The fumes can be hazardous to your health and can chemically damage the ceramic-glass surface.

Care and Cleaning

Cooktop Maintenance

Consistent and proper cleaning is essential to maintaining your ceramic glass cooktop.

Prior to using your cooktop for the first time, apply the recommended CookTop® Cleaning Creme to the ceramic surface. Visit www.sears.com for replacement cooktop cleaner, item number 40079.

Buff with a nonabrasive cloth or no-scratch cleaning pad. This will make cleaning easier when soiled from cooking. The special cooktop cleaning cream leaves a protective finish on the glass to help prevent scratches and abrasions.

Sliding aluminum or copper clad bottom pans on the cooktop can cause metal markings on the cooktop surface. These marks should be removed immediately after the cooktop has cooled using the cooktop cleaning cream. Metal marks can become permanent if not removed prior to future use.

Cookware (cast iron, metal, ceramic or glass) with rough bottoms can mark or scratch the cooktop surface.

Do not:

- Slide anything metal or glass across the cooktop (Figure 48).
- Use cookware with dirt or dirt build up on bottom; replace with clean cookware before using.
- Use your cooktop as a cutting board or work surface in the kitchen.
- Cook foods directly on the cooktop surface without a pan.
- Drop heavy or hard objects on the ceramic glass cooktop, they may cause it to crack.

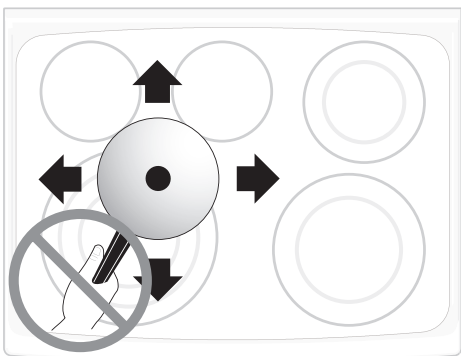

Figure 48: Do not slide pans

Cooktop Cleaning

⚠ WARNING Do not use a cooktop cleaner on a hot cooktop. The fumes can be hazardous to your health, and can chemically damage the ceramic-glass surface.

⚠ CAUTION Before cleaning the cooktop, be sure the controls are turned to off and the cooktop is cool. The glass surface could be hot and burns may occur if the glass surface is touched before it has cooled sufficiently.

For light to moderate soil:

Apply a few drops of CookTop® Cleaning Creme directly to the cooktop. Use a paper towel or use a non-abrasive plastic type no-scratch cleaning pad to clean the entire cooktop surface. Make sure the cooktop is cleaned thoroughly, leaving no residue.

For heavy, burned on soil:

Apply a few drops of CookTop® Cleaning Creme directly to the soiled area. Rub the soiled area using a non-abrasive plastic type no-scratch cleaning pad, applying pressure as needed. Do not use the pad you use to clean the cooktop for any other purpose.

If soils remain, carefully scrape soils with a metal razor blade scraper (Figure 49) by holding scraper at a 30 degree angle to the surface. Remove loosened soils with cooktop cleaning cream and buff surface clean.

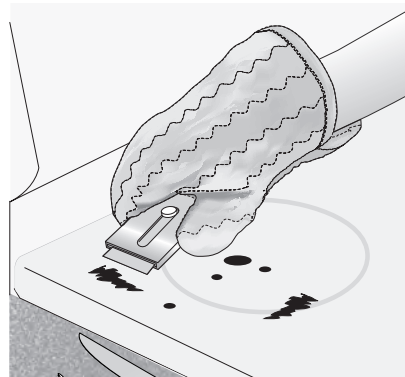

Figure 49: Using razor blade to remove burned on matter

Plastic or foods with a high sugar content:

These types of soils need be removed immediately if spilled or melted onto the ceramic cooktop surface. Permanent damage (such as pitting of the cooktop surface) may occur if not removed immediately. After turning the surface elements off, use a razor blade scraper or a metal spatula with a mitt and scrape the soil from the hot surface (as illustrated). Allow the cooktop to cool, and use the same method for heavy or burned on soils.

Care and Cleaning (cont)

Do not use the following on the cooktop:

- Do not use abrasive cleaners and scouring pads, such as metal and some nylon pads. They may scratch the cooktop, making it more difficult to clean.
- Do not use harsh cleaners, such as chlorine bleach, ammonia or oven cleaners, as they may etch or discolor the cooktop.
- Do not use dirty sponges, cloths or paper towels, as they can leave soil or lint on the cooktop which can burn and cause discoloration.

Important note:

Damage to the ceramic glass cooktop may occur if you use an abrasive type cleaning pad. Only use cleaning products that have been specifically designed for ceramic glass cooktops.



General Cleaning

Refer to the Cleaning recommendation table in this section for more detailed information about cleaning specific parts of the range.

⚠ CAUTION Before manually cleaning any part of the range, be sure all controls are turned off and the range is cool. The range may be hot and can cause burns.

⚠ CAUTION Ammonia must be rinsed before operating the oven. Provide adequate ventilation.

Aluminum foil and utensils

⚠ WARNING Never cover any slots, holes or passages in the oven bottom or cover an entire oven rack with materials such as aluminum foil. Aluminum foil linings may trap heat, causing a fire hazard.

⚠ WARNING Protective Liners — Do not use aluminum foil to line the oven bottom. Only use aluminum foil as recommended in this manual. Improper installation of these liners may result in risk of electric shock, or fire.

- Aluminum foil - Use of aluminum foil on a hot cooktop can damage the cooktop. Do not use thin aluminum cooking utensils or allow aluminum foil to touch the surface elements under any circumstances.
- Aluminum utensils - The melting point of aluminum is much lower than that of other metals. Care must be taken when aluminum pots or pans are used on the cooktop. If aluminum pans are allowed to boil dry when using the cooktop, not only will the utensil be damaged or destroyed, but it may fuse to, break or mark the ceramic glass surface, permanently damaging the cooktop surface.

Replacing the oven light

⚠ CAUTION Be sure the oven is unplugged and all parts are cool before replacing oven light.

The interior oven lights are located at the rear of the oven cavity. (See [Figure 50](#)).

To replace the oven interior light bulbs:

Important note:

Use a paper towel or cotton glove while handling the new bulb when installing.

1. Turn electrical power off at the main source or unplug the appliance.
2. Replace bulb with a new 25 watt halogen bulb.
3. Turn power back on again at the main source (or plug the appliance back in).
4. Be sure to reset the time of day on the clock.

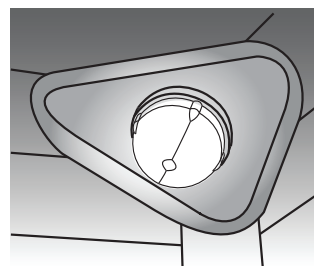

Figure 50: Replacing the oven light

Removing and Replacing the Warmer Drawer

To remove the warmer drawer:

⚠ WARNING Electrical shock hazard can occur and result in serious injury or death. Disconnect appliance from electric power before cleaning and servicing the warmer drawer.

1. Turn power OFF to the appliance before removing the warmer drawer.
2. Open the warmer drawer completely.
3. On left warmer drawer rail, locate black release lever and press up with finger while pulling out slightly on the oven drawer handle. On right warmer drawer rail, locate black release lever and press down with finger while pulling out slightly on the warmer drawer handle (See Figure 51).

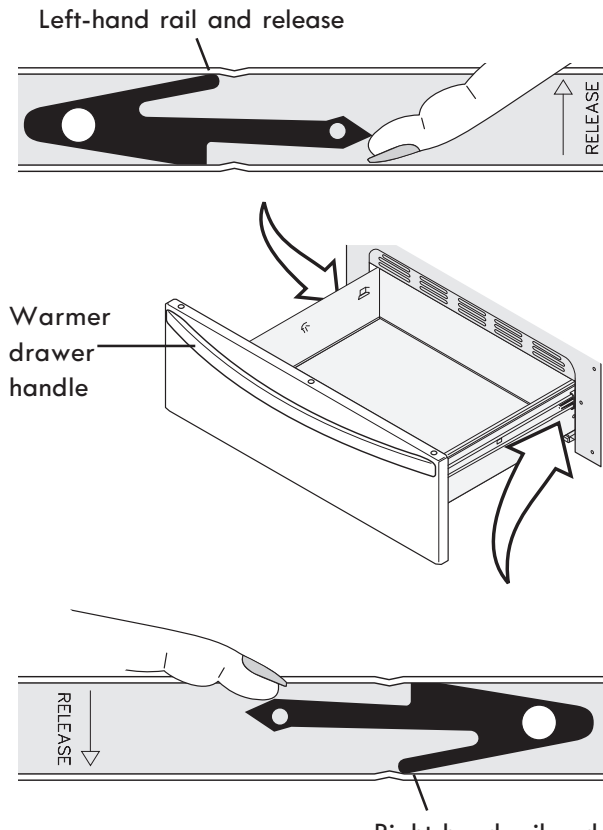

Figure 51: Removing the warmer drawer

4. The warmer drawer should now be released from the rails. Remove warmer oven drawer (using level and square motion) completely out and away from the appliance.

To replace the warmer drawer:

1. Pull the bearing glides to the front of the outer compartment glide channels until they snap into place (See Figure 52).

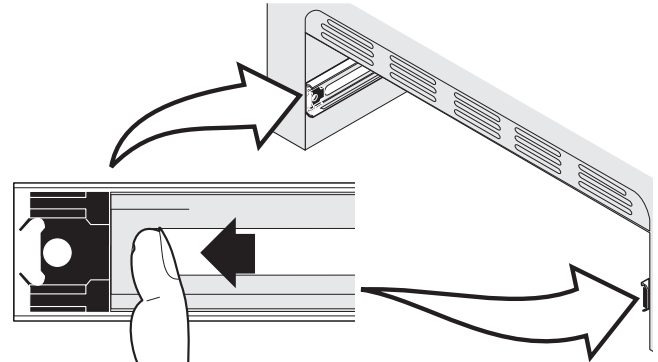

Figure 52: Bearing glide placement

2. Carefully line up both sides of the warmer drawer glide rails to the outer compartment glide channels located inside the empty warmer drawer compartment (See Figure 53).

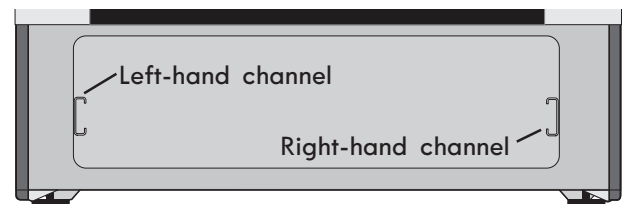

Figure 53: Channel alignment

3. While holding the warmer drawer level and square using the warmer drawer handle, push (do not force) the warmer drawer all the way into the outer compartment glide channels all the way into the range. Open the warmer drawer again to verify the glides have seated.
4. If you do not hear the levers click or the bearing glides do not feel seated remove the warmer drawer and repeat Steps 1 through 3 again. This will minimize possible damage to the bearing glides.

Removing and Replacing the Oven Door

⚠ CAUTION The door is heavy. For safe, temporary storage, lay the door flat with the inside of the door facing down.

To remove the oven door:

1. Open oven door completely, horizontal with floor (See [Figure 54](#)).
2. Pull the door hinge locks on both left and right door hinges down from the oven frame completely toward the oven door (See [Figure 55](#)). A tool such as a small flat-blade screwdriver may be required.
3. Firmly grasp both sides of oven door along the door sides. Do not use the oven door handle (See [Figure 56](#)).
4. Close the door to approximately 10 degrees from the oven door frame.
5. Lift the oven door hinge arms over the roller pins located on each side of the oven frame (See [Figure 56](#)).

To Replace Oven Door:

1. Firmly grasp both sides of oven door along the door sides. Do not use the oven door handle (See [Figure 56](#)).
2. Holding the oven door at the same angle as the removal position (See [Figure 56](#)), seat the hook of the hinge arm over the roller pins located on each side of the oven door frame (See [Figure 57](#)). The hook of the hinge arms must be fully seated onto the roller pins.
3. Fully open the oven door, horizontal with floor (See [Figure 54](#)).
4. Push the door hinge locks up toward and into the oven frame on both left and right oven door hinges to the locked position ([Figure 55](#)).
5. Close the oven door.

Important:

Special Door Care Instructions

Most oven doors contain glass that can break.

- Do not close the oven door until all the oven racks are fully in place.
- Do not hit the glass with pots, pans, or any other object.
- Scratching, hitting, jarring, or stressing the glass may weaken its structure causing an increased risk of breakage at a later time.

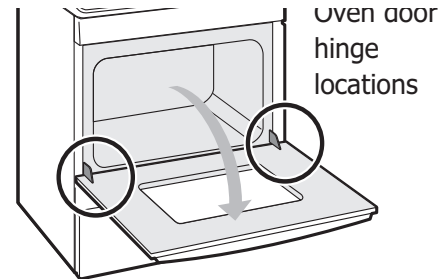

Figure 54: Door hinge location

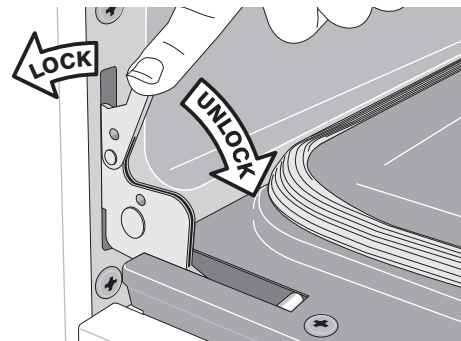

Figure 55: Door hinge locks

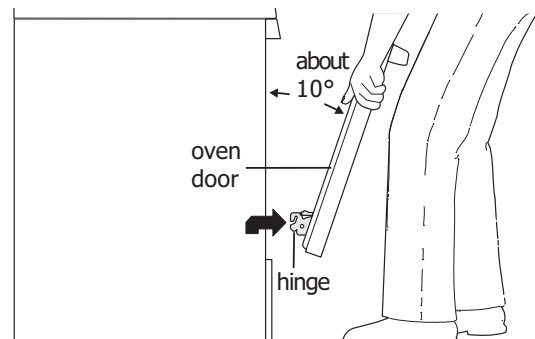

Figure 56: Holding door for removal

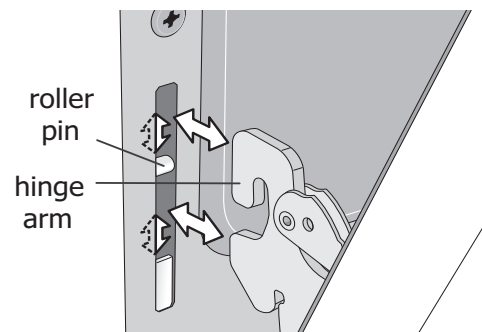

Figure 57: Location of hinge arm and roller pin





Before You Call

Oven Baking

For best cooking results, heat the oven before baking cookies, breads, cakes, pies or pastries, etc. There is no need to preheat the oven for roasting meat or baking casseroles.

The cooking times and temperatures needed to bake a product may vary slightly from your previously owned appliance.

Baking Problems and Solutions

Baking Problems	Causes	Corrections
Cookies and biscuits burn on the bottom. 	<ul style="list-style-type: none"> • Cookies and biscuits put into oven before the preheating time is completed. • Oven rack is overcrowded. • Dark pans absorb heat too fast. 	<ul style="list-style-type: none"> • Allow oven to preheat to desired temperature before placing food in oven. • Choose pan sizes that will permit 2" to 4" of air space (5.1 cm to 10.2 cm) on all sides when placed in the oven. • Use a medium weight baking sheet.
Cakes too dark on top or bottom 	<ul style="list-style-type: none"> • Cakes put in oven before preheating time is completed. • Rack position too high or too low. • Oven too hot. 	<ul style="list-style-type: none"> • Allow oven to preheat to the selected temperature before placing food in the oven. • Use proper rack position for baking needs. • Set oven temperature 25°F/13°C lower than recommended.
Cakes not done in center. 	<ul style="list-style-type: none"> • Oven too hot. • Incorrect pan size. • Pan not centered in oven. 	<ul style="list-style-type: none"> • Set oven temperature 25°F/13°C lower than recommended. • Use pan size suggested in recipe. • Use proper rack position and place pan so there is 2" to 4" (5.1 cm to 10.2 cm) of space on all sides of pan.
Cakes not level. 	<ul style="list-style-type: none"> • Oven not level. • Pan too close to oven wall or rack overcrowded. • Pan warped. 	<ul style="list-style-type: none"> • Place a marked glass measuring cup filled with water on the center of the oven rack. If the water level is uneven, refer to the installation instructions for leveling the oven. • Be sure to allow 2" to 4" (5.1 cm to 10.2 cm) of clearance on all sides of each pan in the oven. • Do not use pans that are dented or warped.
Foods not done when cooking time is over. 	<ul style="list-style-type: none"> • Oven too cool. • Oven overcrowded. • Oven door opened too frequently. 	<ul style="list-style-type: none"> • Set oven temperature 25°F/13°C higher than suggested and bake for the recommended time. • Be sure to remove all pans from the oven except the ones to be used for baking. • Open oven door only after shortest recommended baking time.

Solutions to Common Problems

Before you call for service, review the following list. It may save you time and expense. Possible solutions are provided with the problem listed:

Problem	Solution
Poor baking results	<ul style="list-style-type: none"> • Many factors effect baking results. Use proper oven rack position. Center food in the oven and space pans to allow air to circulate. Preheat oven to the set temperature before placing food in the oven. Try adjusting the recipe's recommended temperature or baking time. See "Adjusting Oven Temperatures" on page 32 if you feel the oven is too hot or cold. • If your oven is cooking poorly, or self clean is performing badly, perform the following check: Press Broil; Press START. Place your hand near the handle on the oven door. Between the door and the control panel you should feel a rush of air on your hand. If so, your unit is functioning properly and you have had a Power Failure in your home. If no air stream is present, call a service technician to replace your cooling fan
Oven does not operate.	<ul style="list-style-type: none"> • The time of day is not set. The oven clock must first be set in order to operate the oven. • Be sure oven controls are set properly. See "Minimum & Maximum Control Settings " on page 17 and review instructions for the desired cooking function in this manual. • Service wiring is not complete.
Oven light does not work.	<ul style="list-style-type: none"> • Be sure the oven light is secure in the socket. See "Replacing the oven light" on page 37.
Flames inside oven or smoking from oven vent.	<ul style="list-style-type: none"> • Excessive spills in oven. Grease or food spilled onto oven bottom or oven cavity. Wipe up excessive spills before starting oven. If flames or excessive smoke are present when using broil, see "Setting Broil" on page 24.
Self clean does not work.	<ul style="list-style-type: none"> • Oven control not set properly. Review "Recipe Recall" on page 32.
Oven racks discolored or do not slide easily.	<ul style="list-style-type: none"> • Oven racks left in oven cavity during self clean. Always remove oven racks from oven cavity before starting a self-clean cycle. Clean using a mild abrasive cleaner following manufacturer's instructions. Rinse with clean water, dry, and replace in oven.
Oven smokes excessively when broiling.	<ul style="list-style-type: none"> • Incorrect setting. Follow broiling instructions in "Setting Broil" on page 24 • Meat too close to the broil element. Reposition broil rack to provide proper clearance between the meat and broil element. Remove excess fat from meat. Cut remaining fatty edges to prevent curling. • Grease build up on oven surfaces. Regular cleaning is necessary when broiling frequently. Grease or food splatters will cause excessive smoking.
Oven control panel beeps and displays any F or E code error.	<ul style="list-style-type: none"> • Oven control has detected a fault or error condition. Press STOP to clear the error code. Try bake or broil function. If the F or E code error repeats, turn off power to appliance, wait 5 minutes and then repower appliance. Set clock with correct time of day. Try bake or broil function again. If fault recurs, press STOP to clear.
Soil not completely removed after self clean.	<ul style="list-style-type: none"> • Self Clean was interrupted. Review instructions in "Recipe Recall" section on page 32. • Excessive spills on oven bottom. Clean before starting self clean. • If your oven is cooking poorly, or self clean is performing badly, perform the following check: Press Broil; Press START Place your hand near the handle on the oven door. Between the door and the control panel you should feel a rush of air on your hand. If so, your unit is functioning properly and you have had a Power Failure in your home. If no air stream is present, call a service technician to replace your cooling fan

Before You Call

Convection fan does not rotate.	<ul style="list-style-type: none">• Oven door is open. Convection fan will turn off if oven door is opened when convection is active. Close oven door.
Surface element is too hot or not hot enough.	<ul style="list-style-type: none">• Incorrect surface control setting. Adjust power level setting.
Surface element does not heat or does not heat evenly.	<ul style="list-style-type: none">• Be sure the correct surface control is turned on for element needed.• Lightweight or warped pans used. Use only flat, evenly balanced, medium or heavy-weight cookware. Flat pans heat better than warped pans. Cookware materials and weight of the material affect heating. Heavy and medium-weight pans heat evenly. Because lightweight pans heat unevenly, foods may burn easily.
Scratches or abrasions on cooktop surface.	<ul style="list-style-type: none">• Coarse particles such as salt or hardened soils between cooktop and utensils can cause scratches. Be sure cooktop surface and bottoms of utensils are clean before usage. Small scratches do not affect cooking and will become less visible with time.• Cleaning materials not recommended for ceramic-glass cooktop have been used. Apply the recommended CookTop® Cleaning Creme to the ceramic surface (on the web visit www.sears.com for replacement cooktop cleaner, item number 40079). Buff with a non-abrasive cloth or sponge.• Cookware with rough bottom was used. Use smooth, flat-bottomed cookware.
Brown streaks or specks on cooktop surface.	<ul style="list-style-type: none">• Boilovers are cooked onto surface. Use razor blade scraper to remove soil.
Appliance is not level.	<ul style="list-style-type: none">• Be sure floor is level, strong, and stable enough to adequately support range. If floor is sagging or sloping, contact a carpenter to correct the situation.• Poor installation. Place oven rack in center of oven. Place a level on the oven rack. Adjust leveling legs at base of appliance until the rack is level. Kitchen cabinet alignment may make range appear not level. Be sure cabinets are square and have sufficient room for appliance clearance.
Cannot move appliance easily. Appliance must be accessible for service.	<ul style="list-style-type: none">• Cabinets not square or are built in too tightly. Contact builder or installer to make appliance accessible.• Carpet interferes with appliance. Provide sufficient space so appliance can be lifted over carpet.
Entire appliance does not operate.	<ul style="list-style-type: none">• Make sure power cord is plugged properly into outlet.• Electrical power outage. Check house lights to be sure. Call your local electric company for service outage information.• Service wiring is not complete. Call 1-800-4-MY-HOME® for assistance (See back cover).
Fan noise during cooking operation.	<ul style="list-style-type: none">• A cooling fan may automatically turn on and off to cool internal parts. It is normal, and the fan may continue to run even after oven is turned off.
Areas of discoloration with metallic sheen on cooktop surface.	<ul style="list-style-type: none">• Mineral deposits from water and food. Remove using the recommended CookTop® Cleaning Creme to the ceramic surface (on the web visit www.sears.com for replacement cooktop cleaner, item number 40079). Buff with a non-abrasive cloth or sponge